



Escape route security system – SafeRoute

Table of contents

Introduction	05
Features and characteristics	06
SafeRoute monitors, controls and unlocks doors in case of danger	08
SafeRoute components	10
Choose functions with licence cards and applications	12
System examples	14
Single door system	14
Several door system	15
Airlock door system with automatic doors	16
Network door systems	17
Control units and additional components	18
STL-G door terminal	18
Components for STL-G door terminal	20
SCU-DR – control unit	22
Components for mounting on DIN top hat rails	24
Power supply units	26
SCU-UP – control unit	28
SCU-UP terminal supply sets	30
ST key switches	33
Additional components	34
SLI licence and application cards	38
SLI licence cards	38
SLI-A application cards	40
Door locking devices	42
STV 1xx	42
STV 2xx	44
STV 50x	46
STV-A adapter	48
SVP self-locking emergency escape locks	49
TMS Soft®	50
Central Management Control	52
SCMC20	53
SCMC30	54
SCMC40	54
SCMC80	55
Safety instructions	56
EItVTR	56
EN 13637	57



dormakaba 

Save lives, protect valuables

With regard to safety, doors in emergency exits and escape routes pose an enormous challenge as they have to meet contrasting requirements – saving people's lives on the one hand, while securing property on the other hand.

With escape routes, building regulations require doors to be easily opened from inside without external tools. At the same time, insurers, police and facility operators require the most secure lock possible against misuse and break-ins.

SafeRoute is a modularly constructed escape route security system that convincingly interconnects these contrasting requirements.



Illustration shows STL-G door terminal with backlit SES-UP escape route symbol and Euro profile cylinders. Versions with Swiss round cylinders are also available.



SafeRoute – Features and characteristics

Doors in emergency exits are subject to many different requirements. SafeRoute offers comprehensive functions and options for securing emergency exits, which is why it features a flexible and modular design.

The spectrum of use ranges from simple retrofitting of a door into a secure escape route door to installation of a complex escape route system with central monitoring and control via door management software or Central Management Control panels.

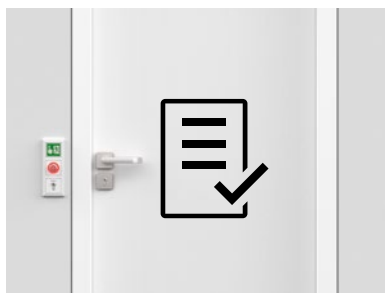

Planning, installation and commissioning – simple and secure

SafeRoute has been developed with simple planning and commissioning in mind. The range of functions for each SafeRoute system can be individually determined through the licence card selected, while the hardware remains largely identical and can therefore be planned very efficiently. All system components are connected in any order with the 4-wire DCW® bus.

Commissioning with preconfigured parameters is enough for many requirements. The status display via the light ring provides assistance during commissioning and also makes operation and service easier as all system statuses are displayed in a differentiated manner.

Further customisation can be made with the TMS Soft® door management software.

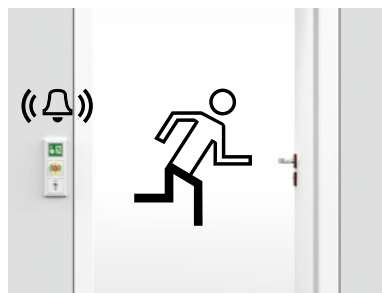

Openly controlled in case of alarms

In cases of alarms or danger, an individual escape route door or a group of doors is unlocked via the emergency button or an external alarm system (smoke detector). The alarm is signalled visually and audibly and if necessary can also be forwarded to higher-level building technology.

Additionally, all new escape route door functions in accordance with EN 13637 are possible with SafeRoute, for example automatic resetting of the alarm, so long as the escape route door has not been opened after activation of the emergency button (otherwise acknowledgement must be done on-site via the key switch). Even a time delay between activation of the emergency button and unlocking is possible (please observe country-specific regulations).

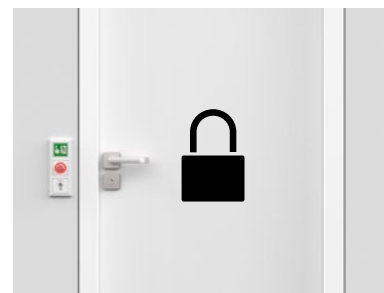

Lock entrances securely

SafeRoute systems automatically lock escape route doors after authorised access. If re-locking is not possible, the open door monitoring will send out an alarm.

- All components in the SafeRoute system are monitored for manipulation and tampering, down to the DCW® bus cable between the components.
- All events are monitored in real time and, if necessary, can be forwarded to external security systems.
- In conjunction with the self-locking emergency escape locks, insurance-compliant locking is automatically created – for increased protection against break-ins even with multipoint locking systems up to RC4 (depending on the door construction).

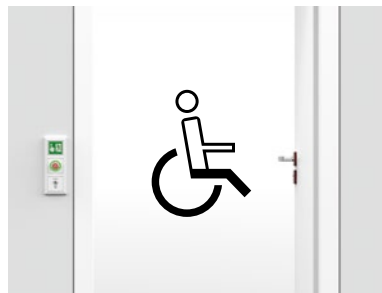
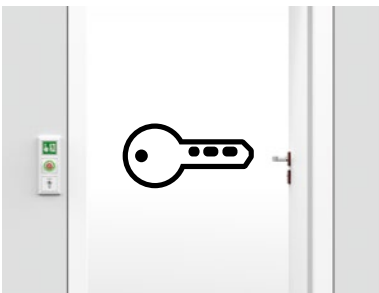

Authorised access

In its simplest version, authorised access is granted by unlocking with the key switch from inside.

Depending on the licence, there are up to three possibilities of unlocking:

- Temporary unlocking for quick movement (locked again after 3-180 seconds)
- Long-term unlocking (locked again after 3-120 minutes)
- Permanent unlocking

With additional components, the range of functions for a door can be expanded (depending on licence):

- DCW® outer key switch
- Touchscreen display with code keypad
- "Permanent open" controlled depending on time of day via integrated timer
- Remote control in conjunction with video monitoring or monitoring from another room, e.g. at prisons, closed departments etc.
- Activation via an access control system

Everyday convenience function: "automated door opening"

With an additional revolving door drive a self-locking motorised panic lock, an escape route door secured with SafeRoute can automatically open after activation or controlled depending on the time of day.

- Comfort in daily operation
- Barrier-free escape routes with "automated door opening"

Network controlled and monitored

All escape route doors monitored with SafeRoute can also be networked over long distances and can be centrally monitored and controlled with the TMS Soft® door management software and SafeRoute Central Management Control panels. Depending on the requirement, the networking is done via LON or LAN. The interfaces to OPC and ESPA enable the integration in existing building management systems.

Escape routes – from simple to complex

Depending on the licence chosen, additional functions and complex escape routes can also be realised.

- Bi-directional escape routes
- Escape routes as a combination of individual doors, e.g. as airlock groups for operating theatres, clean rooms, court rooms, penal institutions etc.
- Logic functions

SafeRoute monitors, controls and unlocks doors in case of danger

SafeRoute monitors and controls the locking devices of doors in escape routes in accordance with the guidelines and standards of EltVTR (German directive for electrical locking systems on escape route doors) and EN 13637. In case of a hazard or malfunctions, the door is unlocked, while it otherwise remains locked on a day-to-day basis.

Escape route door with standard operation

The door is locked. Authorised use is usually made via a key switch on site. Depending on the individual requirement, the use of PIN codes, on-site access controls or an integrated real-time clock are also possible.

The door status is consistently monitored and displayed via the integrated light ring. In special cases, such as attempted tampering, a distinct visual signal as well as an acoustic alarm will be triggered.

Escape route door in case of alarm/danger

The door is locked. It can be unlocked in cases of alarms and danger via the emergency button or an external alarm system (e.g. smoke detector or central fire detection system). Additionally, an audible and visual alarm will be triggered.

Each SafeRoute system can be individually adapted to requirements on site, such as via time-delayed activation of the door in case of alarm and/or automatic resetting of the alarm if the escape route door has not been opened (country-specific regulations must be observed).

Light ring for display of operational status

The light ring on the emergency button provides information with different light signal combinations about the current status of the door and possible events in the SafeRoute system, such as to do with authorised and unauthorised access and attempts at entry, and as visual support for operation and maintenance.

Modular extensions

The range of functions in a SafeRoute system can be individually expanded with applications and further system components, such as for use as a multi-door switchboard and for connecting to the superordinate building control system.



01

Illustrations show the flush-mounted terminal, consisting of the individual components of the SafeRoute control unit (SCU-UP) as a flush-mounted insert with a ST 55 key switch and an STD-UP touchscreen display. The current status of the door is shown via the light ring.

- 01** Standard operation
Door is locked: Light ring is red
- 02** Standard operation
Door is opened, light ring turns green, door can be opened
- 03** In the case of alarm.
Door is unlocked, light ring turns green and flashes yellow, door can be opened
- 04** Tampering notification
Light ring turns red and flashes yellow, door can not be opened, tampering notification for locked system



02

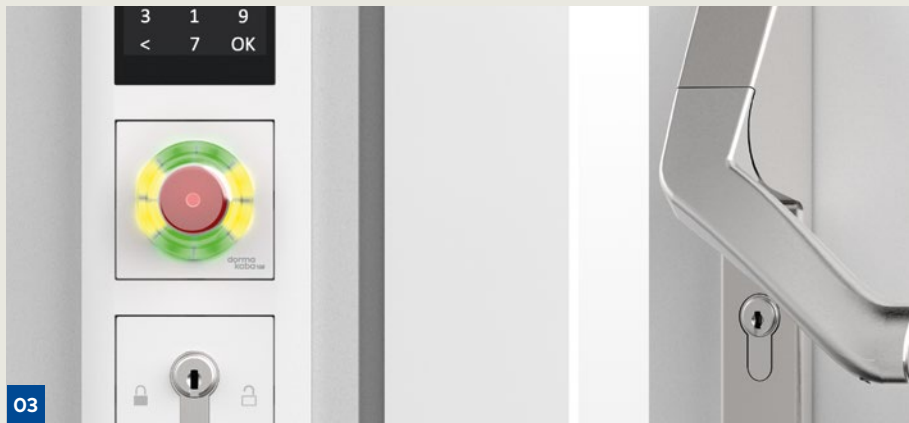

03



04

SafeRoute Components

The basic components in a SafeRoute system are an electric door locking device (STV), a SafeRoute control unit (SCU) with a SafeRoute licence card (SLI) and an emergency button with a connected key switch (ST). With further components, a SafeRoute system can be enhanced and adapted to individual purposes.

The SCU – a central control unit with integrated emergency button

The SCU **SafeRoute Control Unit** becomes a central control unit (master) through the inserted licence card and a connected key switch. Each SCU has an input for connection to a central hazard alert control unit and/or a central fire alarm control unit or a smoke detector for emergency release. External sensors/actuators can be integrated without a DCW® bus interface using additional inputs and outputs. Optional dormakaba DCW® components can be used to expand the functionality of a SafeRoute system as needed. Without a licence card, the identical SCU functions as an additional emergency button (slave), e.g. for bi-directional escape routes (escape route for both directions).

Connect components easily with DCW® bus

Intelligently connected via the DCW® bus (**D**ormakaba **C**onnect and **W**ork), the connected components detect each other and are supplied with power concurrently. Up to four door locking devices can be connected to an SCU control unit (master). In addition, the connection of four similar DCW® components each is possible (e.g. up to four emergency buttons and four key switches). All components are connected in any topology with a four-core cable, and power can be supplied from any point in the system bus. The maximal bus length is 300 m. For maximum utilisation of the cable length, power can be supplied at multiple points.

Building-wide networking

Using the LON and LAN network standards, the escape route door systems in the building can be networked. From licence level SLI Basic upwards, systems with a LON/LAN module can be expanded and centrally monitored and controlled with TMS Soft®. In this way, the SCU (master) forms the interface to the network.

STL-G NT door terminal with integrated power supply unit and backlit SES-UP escape route symbol. Connection to STV 1xx electro-mechanical locking device is only done via a four-wire cable (DCW® bus). Depending on the licence chosen, additional functions and complex escape routes can also be realised.

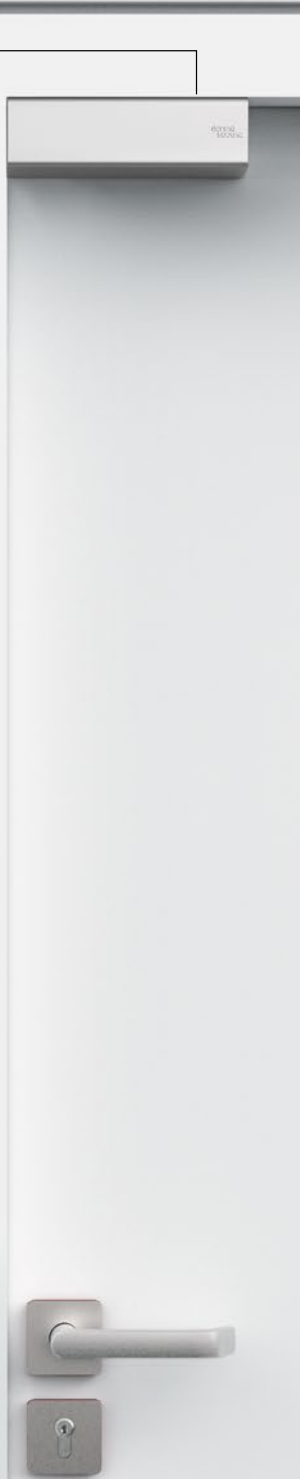

Basic components

STV 1xx
Electromechanical door locking device



STV 2xx
Electromagnetic door locking device



STV 5xx
Electromechanical door locking device for concealed frame installation





STL-G with SCU-TL as master
"All-in-one terminal"
(with or without NT power supply unit)

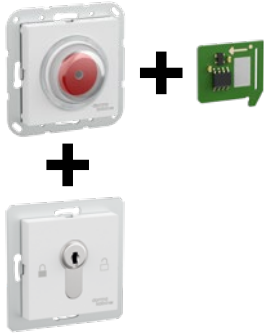

SCU-UP as master
Individual components

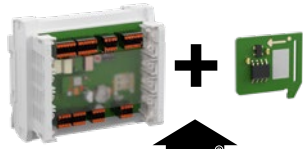

SCU DR as master
Top hat rail mounting and individual components



STL-G (slave)



SCU-UP (Slave)



SafeRoute Control Unit SCU as Master

With the inserted licence card, an SCU becomes the control and monitoring centre (master). A master can monitor and control up to four escape route doors depending on the licence type. Each connected escape route door needs at least one emergency button with a connected key switch and an electric door locking device.

Power for individual components is supplied from any point in the DCW® bus, e.g. through an STL-G with integrated power supply unit or an external power supply unit like PSU-24, NT 24-1.5s or USV-24 3.



Example selection* of optional components

SVP 2xxx DCW®
M-SVP 22xx DCW®
Emergency escape motor lock with automatic locking action



STL-G (slave)
Additional emergency buttons and key switches



SCU-UP (Slave)
Additional emergency buttons and ST key switches



STV-A adapter
For locking devices without DCW®-Bus (certifications in accordance with EltVTR and EN 13637 must be observed)



LON or LAN network adaptors
e.g. as SLAN-DR version



STD-UP touchscreen display
Addition of key switch, simple access control or as "down-counter" for emergency open delay



ST xx DCW®
Additional key switches



SIO-DR I/O module DCW®
expansion for connection of analogue actuators and sensors



SCMC20
Module plate for safety-related switch-off from a panel



TMS Soft®
Parametrisation and management software for Windows PCs for control and monitoring of escape route door systems. With interfaces for external door management systems (e.g. OPC and ESPA).



* The complete list of possible components can be found at www.dormakaba.com/saferoute/downloads.

Choose functions with licence cards and applications

An escape route system can be configured with pre-configured SLI licence cards and SLI-A application cards. The chosen cards are inserted into the SCU and establish the range of functions for a SafeRoute system. If the requirements for the system's range of functions change during operation, adjustment via parametrisation or the selection of a higher licence level or additional application is possible. An exchange of the built-in hardware is not necessary.

License cards are currently available at four levels: SLI Mini, SLI Basic, SLI Standard and SLI Premium. The licence cards remain in the SafeRoute control unit (SCU) during operation. With the inserted licence cards, an SCU becomes a control and monitoring panel (master) with the possibility of using further SCUs (slave). The SLI Mini licence card is sufficient for setting up a simple escape route door.

The SLI-A application cards offer additional flexibility. They can be used to reload specific functions, e.g. logic functions, the operation of up to four self-supporting doors using just one SCU, the configuration of an airlock system and the option of time-delayed activation.



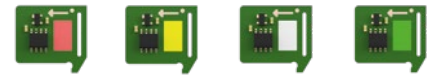

SLI licence card		Mini	Basic	Standard	Premium
Release	Via emergency button (with alarm trigger)	○	○	○	○
Unlock	Via key switch (without alarm trigger)				
	– Short-term unlocking	○	○	●	●
	– Long-term unlocking	-	-	●	●
	– Permanent unlocking	○	○	○	○
	– Operating time of the key switch to trigger the long-term/permanent unlocking mode	-	-	●	●
	– Combi-function temporary, long-term and permanent unlocking feature: each of the unlocking modes can be deactivated	-	-	●	●
	Automatic unlocking at set times daily (timer)	-	-	●	●
	Via an alarm system (fire, danger and smoke detectors, sprinklers, etc.)	○	○	○	○
	Bi-directional escape routes	-	○	○	○
	From outside to inside via external analogue ST (key switch)	○	●	●	●
	From outside to inside via external DCW® ST or SVP/M-SVP 22xx	-	●	●	●
Lock	Automatic re-locking				
	– Following short-term unlocking	○	○	●	●
	– Following long-term unlocking	-	-	●	●
	– If the door has not been opened following activation of the emergency button ¹⁾	-	●	●	●
	– Following closing	-	-	●	●
	Automatic locking at set times daily (timer)	-	-	●	●
	Automatic re-locking following power failure	○	○	○	○
	Reset of the unlocking mode via key/emergency button	○	●	●	●
	Direct connection of motorised locks SVP 2xxx DCW®/M-SVP 22xx DCW®	-	●	●	●
Opt./acoust. display	Status/warning/initialisation display on the light ring				
	– Setting brightness	-	●	●	●
	– Setting flashing frequency	-	-	●	●
	Pre-alarm/main alarm following temporary unlocking and long-term unlocking	○	○	●	●
	Maintenance alarm	○	○	●	●
	Acoustic confirmation upon activation of long-term or permanent unlocking	○	○	●	●
	Alarm time limitation	○	●	●	●
	Alarm management (activation/deactivation of alarms)	-	●	●	●
Monitoring	Tampering monitoring (can be deactivated for maintenance work)	●	●	●	●
	Open door monitoring	○	○	●	●
	Two different time ranges for the pre and main alarms for open door monitoring	-	-	●	●
Access control	Access control via code keypad, e.g. STD-UP touchscreen display	-	-	●	●
	Historical memory with date and time stamp	-	-	○	○
Networking	LON	-	●	●	●
	LAN	-	○	○	○
Miscellaneous	Automatic re-activation following power failure	○	○	○	○
	Parametrisation/visualisation/control via TMS Soft®	-	●	●	●
	Freely programmable inputs/outputs on the SCU	-	●	●	●
	Additional programmable inputs/outputs via SIO-DR or I/O DCW®	-	-	●	●
Central Management Control	Visualisation/control via SCMC80	-	●	●	●
	Central locking/unlocking (not related to safety, locking/release of operating buttons of SCMC80), status display with TE25	-	●	●	●
	Safety-related, central release via SCMC20	-	-	-	●
	Disabling the activation function of the emergency button on the escape door via SCMC20 and SCMC30	-	-	-	●
	Activating time delay T21) via SCMC20 and SCMC40	-	-	-	●
Application cards	Multi-door control	-	■	■	●
SLI-A	Airlock control	-	■	■	●
	Logic functions	-	-	■	●
	Time-delayed release¹⁾	-	■	■	●
	– One time step (configurable)	-	■	■	●

– Not available ○ Available, not configurable ● Available and configurable ■ With application

¹⁾ EN-13637 function.



SafeRoute System examples

One-door systems

Set-up of an individual door as a secured escape route door in accordance with EN 13637 and EltVTR (German directive for electrical locking systems on escape route doors)

Necessary components

- 01** An STL-G NT door terminal as a control and monitoring panel with SCU-TL (master), power supply unit, emergency button, key switch and SLI Mini licence card
- 02** A door locking device (e.g. STV 1xx)
- 03** Connection of components via DCW® bus (four wire J-Y(St)Y cable 2x2x0.8 mm)

Functions

- In standard operation, the door is closed and locked, and can be temporarily or permanently unlocked with the key switch.
- If the door is closed again after authorised access, it is locked automatically.
- If the door remains open after authorised access, a pre-alarm will be triggered off after 30 seconds and a main alarm after another 60 seconds.
- In case of danger, the door will be released by pressing the emergency button or via a connected alarm system, such as a fire detector. In addition, an alarm will be triggered.

Further connection possibilities with SLI Mini licence card

Analogue on the SCU-TL

Input 1: static drive
Input 2: Fire or smoke detection system

Output 1: locked
Output 2: General alarm (alarm signal)

DCW® bus interface

STV 1xx, STV 2xx, STV 5xx, max. 4 door locking devices
STV-A adapter for analogue dormakaba door locking devices or for integration of foreign products with analogue switch contacts without DCW® bus interface (certifications in accordance with EltVTR or EN 13637 must be observed)



Direct link to the specification text
www.dormakaba.com/saferoute/downloads



Multi-door systems

Set-up of an escape route system with up to four doors in accordance with EN 13637 and EltVTR.

Necessary components

- 01** An SCU-DR as a control and monitoring centre (master) with SLI Basic licence card and SLI-A multi-door control application
- 02** Central power supply unit e. g. NT-24 5
- 03** 4 STL-G door terminals with SCU-TL (slave), emergency button and key switch
- 04** 4 door locking devices (e.g. STV 1xx)
- 05** Connection of components via DCW® bus (four wire J-Y(St)Y cable 2x2x0.8 mm)

Functions

- In standard operation, the doors are closed and locked, and can be temporarily or permanently unlocked with the key switch. Each door is individually operable.
- If a door is closed again after authorised access, it is locked automatically.
- If a door remains open after authorised access, a pre-alarm will be triggered off after 30 seconds and a main alarm after another 60 seconds.
- In case of danger, the doors will be centrally released by pressing the respective emergency button or via a connected alarm system, e.g. a hazard or fire alarm.
- Linking of doors in the TMS Soft® management software with real-time monitoring with optional LON/LAN module on the SCU-DR (master).

Further connection possibilities with SLI Basic licence card

Analogue on the SCU (master and slave), configurable

Input 1: static drive
 Input 2: Fire or smoke detection system
 Output 1: locked
 Output 2: General alarm (alarm signal)

DCW® bus interface

STV 1xx, STV 2xx, STV 5xx, max. 4 door locking devices
 STV-A adapter for analogue dormakaba door locking devices or for integration of foreign products with analogue switch contacts without DCW® bus interface (certifications in accordance with EltVTR or EN 13637 must be observed)

SVP 2xxx DCW®, M-SVP 22xx DCW®, motorised emergency escape locks for increased protection against break-in (up to RC4)

ST 3x DCW®, ST 55 DCW® LED, max. 4 additional key switches

STD-UP touchscreen display as additional operative element and as down-counter for delayed activation, maximum four displays

RMZ DCW®, smoke detector/smoke detector with integrated power pack

RS232 interface on the SCU-DR (master)

LON/LAN adapter SLON-UP, SLON-DR, SLAN-DR

Parametrisation via TMS Soft®



Direct link to the specification text
www.dormakaba.com/saferoute/downloads



Airlock door system with automatic doors

Requirement: Set-up of a secured escape route with two automatic doors in accordance with EN 13637 and EltVTR (German directive for electrical locking systems on escape route doors). As airlock network for operating theatre entrances, clean rooms, court rooms, penal institutions etc.

Necessary components

- 01** An STL-G door terminal as a control and monitoring panel with SCU-TL (master), emergency button, key switch, SLI Mini licence card and SLI-A airlock control unit application
- 02** An STL-G door terminal with SCU-TL (slave), emergency button and key switch
- 03** 2 door locking devices (e.g. STV 1xx)
- 04** 2 revolving door drives, e.g. ED 100 or ED 250 with safety sensor
- 05** 2 motorised emergency escape locks, e.g. SVP 2xxx DCW®
- 06** 2 STD-UP touchscreen displays as access controls for automatic door opening
- 07** Connection of components via DCW® bus (four wire J-Y(St)Y cable 2x2x0.8 mm)
- 08** 2 wall buttons for opening doors from inside, e.g. Magic Switch sensor buttons, connection direct to the SCU The power supply is supplied from the power supply unit from the revolving door drives.

Functions

- In standard operation, the doors are closed and locked. A door can only be opened if the other is closed and locked (airlock function).
- The airlock can be permanently unlocked with the key switch, e.g. for transport purposes.
- The length of time the door is open can be defined freely.
- If a door is closed again after authorised access, it is locked automatically.
- If a door remains open after authorised access, a pre-alarm followed by a main alarm will be triggered after a pre-defined period.
- In case of danger, the doors will be released by pressing the emergency button or via a connected alarm system, such as a fire detector. In addition, an alarm will be triggered.
- Historical memory with date and time stamp
- Integration of doors into the TMS Soft® management software with real-time monitoring with a LON module in one of the STL-G door terminals
- Access control via code keypad with STD-UP touchscreen display



Network door systems

Further connection possibilities with SLI Standard licence card

Analogue on the SCU (master and slave), configurable

2 inputs:

- One input used for the buttons
- One input used, e.g. for fire or smoke detection system

2 outputs:

- One output configurable for the automatic door drive
- One output free for controlling external components, e.g. an external alarm siren (general alarm)

DCW® bus interface

STV 1xx, STV 2xx, STV 5xx, max. 4 electric locking devices

STV-A adapter for analogue dormakaba door locking devices or for integration of foreign products with analogue switch contacts without DCW® bus interface (certifications in accordance with EltVTR or EN 13637 must be observed)

STV-ETS for connecting dormakaba turnstiles

SVP 2xxx DCW®, M-SVP 22xx DCW®, motorised emergency escape locks for increased protection against break-in (up to RC4)

SIO-DR and I/O DCW® module, additional programmable inputs/outputs

ST 3x DCW®, ST 55 DCW® LED, max. 4 additional key switches

STD-UP touchscreen display with code keypad

RMZ DCW®, smoke detector/smoke detector with integrated power pack

RS232 interface on the SCU (master)

LON/LAN adapter SLON-UP, SLON-DR, SLAN-DR

Parametrisation via TMS Soft®

All door systems can be configured, monitored and controlled building-wide with TMS Soft® via the LON or LAN network.

In addition to the door systems, the following components are needed

- 01** For each door system, a LON/LAN interface (e.g. SLON-UP or SLAN-DR) on the SCU-xx (master) with SLI Basic licence card or above (plus applications if necessary)
- 02** A PC with LON/LAN interfaces and TMS Soft®
- 03** LON and/or LAN network
- 04** Optional Central Management Control panels for control and monitoring without PC (LON)

Functions

The scope of configurable functions depends on the SLI licence card inserted and SLI-A applications.

- Centrally control and monitor individual doors and door areas
- Log entries and cases of alarms with date and time stamps
- Configure doors and store time profiles
- Interfaces to external building management systems (e.g. OPC and ESPA)
- Assignment of doors for airlock areas when used in airlock application (includes multi-door licence)

Direct link to the specification text
www.dormakaba.com/saferoute/downloads



STL-G door terminal – SCU-TL control unit with emergency button and key switch



The STL-G door terminal is comprised of the SCU-TL components with emergency button and key switch in a surface-mounted case. Together with an electrical locking device, the STL-G door terminal fulfils the requirements of EN 13637 and EltVTR (German directive for electrical locking systems on escape route doors).

Together with a licence card, the SCU-TL becomes a control and monitoring panel (master). Without a licence card, the STL-G door terminal can also be used as an additional door terminal for an escape route door as a "slave" in a group.

Equipment and features

- Tampering-protected door terminal housing made of coated light metal frame and plastic front panel made of robust ABS VO
- Illuminated non-locking emergency button
- 8-fold segmented light ring as status display
- Integrated alarm siren
- Key switch for alarm acknowledgement, locking and unlocking with holder for 30/10 profile half cylinder or Swiss round cylinder, e.g. dormakaba penta
- Range of functions depends on the selected licence card and other possible applications
- Functions can be freely configured with TMS Soft® (from SLI Basic licence card upwards)
- Available with integrated power supply unit
- Comfortable installation thanks to hinged housing
- Easy wiring and reliable operation thanks to DCW® bus technology
- Easy set-up with "one-button commissioning"



- 01** System 55 shaft, slot for flush-mounted modules, e.g. for backlit SES-UP escape route symbol (accessories)
- 02** SafeRoute SCU-TL control unit with slot for an SLI licence card
- 03** Light ring for status display
- 04** Non-locking emergency button
- 05** Key switch with holder for profile half cylinder or Swiss round cylinder
- 06** Alarm siren and cover contact
- 07** Integrated power supply unit (for STL-G version)
- 08** STL-G switches (accessories)
- 09** SLON-UP LON adapter (accessories)

SCU-TL Connection possibilities and possible accessories depending on licence card	SLI Mini	SLI Basic	SLI Standard	SLI Premium
Internal ST key switch	○	●	●	●
Analogue				
Input 1: "Static drive" default	○	●	●	●
Input 2: "Fire or smoke detection system" default	○	●	●	●
Output 1: "Locked" default	○	●	●	●
Output 2: "General alarm (alarm signal)" default	○	●	●	●
DCW® bus interface				
Max. 4 STV 1xx, STV 2xx, STV 5xx, STV-ETS electric locking devices (for connecting dormakaba turnstiles) or STV-A adapter (for analogue dormakaba door locking devices or for integration of foreign products with analogue switch contacts without DCWR bus interface; certifications in accordance with EitVTR or EN 13637 must be observed)	○	○	○	○
SVP 2xxx DCW®, M-SVP 22xx DCW®, motorised emergency escape locks for increased protection against break-in (up to RC4) and with automatic doors	-	●	●	●
I/O module DCW® additional module with 4 analogue inputs and outputs for integrating sensors/actuators	-	-	●	●
ST 3x DCW®, ST 55 DCW® LED, max. 4 additional key switches	-	●	●	●
SCU-UP or SCU-TL (without licence card) as "slave", emergency button with ST connection 1, max. 4 more SCUs	-	●	●	●
- as bi-directional escape route	-	●	●	●
- as airlock or multi-door system	-	■	■	●
STD-UP touchscreen display (max. 4)	-	■	■	●
- as "down counter" for delayed release	-	-	●	●
- as access control with code keypad	-	-	●	●
RMZ DCW®, smoke detector/smoke detector with integrated power pack	-	○	○	○
RS232 interface				
LON/LAN adapter SLON-UP, SLON-DR, SLAN-DR	-	○	●	●
Parametrisation via TMS Soft®	-	●	●	●
Central Management Control				
As per license model with LON/LAN networking (see page 13)	-	-	-	●

- Not available ○ Available, not configurable ● Available and configurable ■ With application

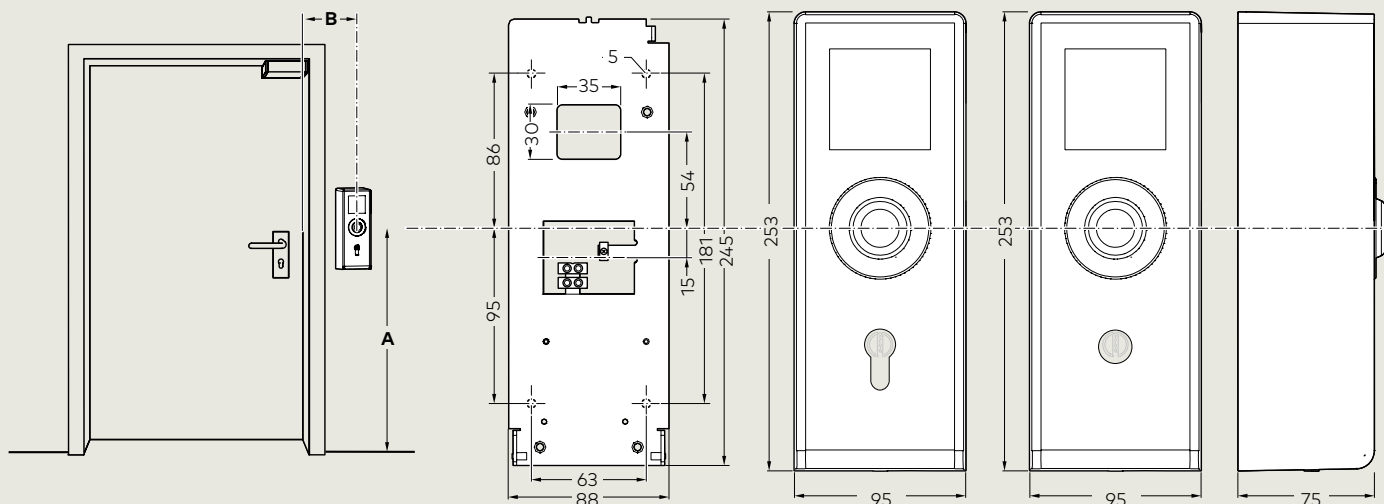

A EitVTR = 850 – 1200 mm
A EN 13637 = 800 – 1200 mm
B EN 13637 = max. 600 mm

STL-G 4xx for
profile cylinder

STL-G 6xx for
Swiss round
cylinders

Colour variants and additional components

The STL-G door terminal is available in different colour variants. Other colours are also available on request. Each STL-G terminal can be equipped with an additional component instead of the standard blind cover, e.g. backlit SES-UP escape route symbol or STD-UP touchscreen display with code keypad as access control and as "down counter" for delayed release. Depending on the equipment, different licence cards and applications are necessary for operation.

Frames

- White P 100, similar to RAL 9016
- Green P 400, similar to RAL 6001
- Stainless-steel finish Niro P 700, similar to RAL 9006
- Colour shades in accordance with RAL available on request

Front

- Black P 190, similar to RAL 9016
- White P 100, similar to RAL 9016
- Green P 400, similar to RAL 6001
- Stainless-steel finish Niro P 700, similar to RAL 9006
- Colour shades in accordance with RAL available on request



01



02



03



04

Technical data

Power supply

Version without a power supply unit:
via DCW® bus 24 V DC ± 10%

Version with a power supply unit:

above 230 V AC ± 10% 24 V DC

Output voltage 1 A

Output current max.

Power input

Closed-circuit current 65 mA

during alarm 100 mA

Class of protection IP 32

Temperature range -10 °C to +55 °C

Rel. Humidity up to 93% (non-condensing)

Dimensions (W x H x D) approx. 95 x 253 x 75 cm

STL-G door terminal

Included in supplied package: STL-G door terminal with integrated SCU-TL control unit with emergency button and key switch, emergency exit sticker, fastening material and blind covering (backlit SES-UP escape route symbol, STD-UP touchscreen display and lock cylinders are not included in supplied package)

Colour Frame/front	Article no.	
	Without power supply unit	With Power supply unit

Versions for profile cylinders

STL-G	Colour	Without power supply unit	With Power supply unit
STL-G x10/NT	White/black	56430x10	56431x10
STL-G x11/NT	White/white	56430x11	56431x11
STL-G x12/NT	White/green	56430x12	56431x12
STL-G x14/NT	White/stainless steel	56430x14	56431x14
STL-G x20/NT	Green/black	56430x20	56431x20
STL-G x21/NT	Green/white	56430x21	56431x21
STL-G x22/NT	Green/green	56430x22	56431x22
STL-G x24/NT	Green/stainless steel	56430x24	56431x24
STL-G x40/NT	Stainless steel/black	56430x40	56431x40
STL-G x41/NT	Stainless steel/white	56430x41	56431x41
STL-G x42/NT	Stainless steel/green	56430x42	56431x42
STL-G x44/NT	Stainless steel/stainless steel	56430x44	56431x44
STL-G x99/NT	Other colour/other colour (in accordance with RAL)	56430x99	56431x99

x = 4 in design for profile cylinder PZ

x = 6 in design for Swiss round cylinder CH - RZ



05



06



07



08

STL-G colour and design examples

- 01 STL-G 421 with blind covering
- 02 STL-G 414 with optional SES-UP
- 03 STL-G 612 with optional SES-UP
- 04 STL-G 440 with optional SES-UP

Additional components

- 05 Backlit SES-UP escape route symbol
- 06 STD-UP touchscreen display
- 07 SLON-UP network adapter
- 08 STL-G V switches

Additional components for the STL-G door terminal**Article no.**

SES-UP	Backlit escape route symbol	56490220
STD-UP	Touchscreen display, code keyboard as access control and as "down counter" for delayed release	56490200
SLON-UP	LON network adapter The connection is established on the RS232 interface of the SCU control unit (master). The SLI Basic licence card is the minimum requirement.	56450012
STL-G V	Distributor boards with ribbon cable to connect to the SCU-TL for convenient wiring of all components in a SafeRoute system in the door terminal housing	56430900



SCU-DR – Control unit for mounting on DIN top hat rails



Together with a licence card, the SCU-DR is operated as a control unit and monitoring panel (master). For setting up an emergency exit and escape route system in accordance with EN 13637 or EltVTR, at least one emergency button and one key switch (e.g. SCU-UP 2-item supply set or STL-G surface-mounted terminal) as well as a rod lock door locking device are necessary. Mounting is done locally on a DIN top hat rail or in the NT G1/NT G2 housing.

Equipment and features

- Integrated I/O module with four opto-coupler inputs for transmitting external signals and control commands, e.g. access control, analogue locks (SVP 4xxx/6xxx), or inhibiting input for burglary detection system (energised between 5 V and 28 V AC/DC) and four outputs for operating external components and for outputting floating contacts
- The default parameters can be adapted to requirements depending on licence and application.
- Display with LEDs for supporting configuration
- Installation on TS35 top hat rail as per EN 50022
- Easy wiring and reliable operation thanks to DCW® bus technology
- Easy set-up with "one-button commissioning"

SCU-DR

SafeRoute control unit for top hat rail mounting

56412300

Technical data SCU-DR

Power supply via DCW® bus 24 V DC ± 10%

Power input 30 mA

Inputs In 1 to In 4 at 5 V to 28 V AC/DC per input:

at 5 V:	3 mA
at 12 V:	8 mA
at 24 V:	17 mA
at 28 V:	28 mA

Outputs Out 1 to Out 2 For each active relay, the power input goes up by approx. 11 mA

Class of protection IP 20

Temperature range -10 °C to +55 °C

Rel. Humidity up to 93% (non-condensing)

Dimensions (W x H x D) approx. 106 x 92 x 65 cm

SCU-DR connection possibilities and possible accessories depending on licence card	SLI Basic	SLI Standard	SLI Premium
Analogue			
4 outputs and inputs for each	●	●	●
Tamper switch input (external cover/housing contact, opener)	○	○	○
Alarm system output, e.g. fire or smoke detector	○	○	○
DCW® bus interface			
Max. 4 STV 1xx, STV 2xx, STV 5xx, STV-ETS electric locking devices (for connecting dormakaba turnstiles) or STV-A adapter (for analogue dormakaba door locking devices or for integration of foreign products with analogue switch contacts without DCWR bus interface; certifications in accordance with EltVTR or EN 13637 must be observed)	○	○	○
SVP 2xxx DCW®, M-SVP 22xx DCW®, motorised emergency escape locks for increased protection against break-in (up to RC4)	●	●	●
ST 3x DCW®, ST 55 DCW® LED, max. 4 additional key switches	●	●	●
SCU-UP or SCU-TL (without licence card) as "slave", emergency button with ST connection 1, max. 4 more SCUs	●	●	●
- as bi-directional escape route	■	■	●
- as airlock or multi-door system	-	●	●
STD-UP touchscreen display (max. 4)	-	●	●
- as "down counter" for delayed release	-	●	●
- as access control with code keypad	-	●	●
RMZ DCW®, smoke detector/smoke detector with integrated power pack	○	○	○
SIO-DR I/O module DCW® additional module with 4 analogue inputs and outputs for integrating sensors/actuators, for top hat rail mounting	●	●	●
RS232 interface			
LON/LAN adapter SLON-UP, SLON-DR, SLAN-DR	○	●	●
Parametrisation via TMS Soft®	●	●	●
Central Management Control			
As per license model with LON/LAN networking (see page 13)	-	-	●

- Not available ○ Available, not configurable ● Available and configurable ■ With application



SafeRoute components

for mounting on DIN top hat rails



SIO-DR

Bus coupler module for connecting products with analogue switch contacts to the DCW® bus.

4 opto-coupler inputs (interface connection with signals between 5-28 V AC/DC) for external actuator control. 4 floating outputs for control of external components or to emit signals. Addresses for different requirements are preconfigured. The SLI Standard licence card is the minimum requirement.

- Individual requirements can be freely set with the TMS Soft configuration software (delayed activation, delayed deactivation, pulse etc.).

SIO-DR	Additional module with 4 analogue inputs and outputs, for mounting on DIN top hat rails, power supply via DCW® bus Closed-circuit current power input 6 mA, active relay max. 51 mA Power input for inputs per input: <ul style="list-style-type: none"> • 3 mA at 5 V • 8 mA at 12 V • 17 mA at 24 V • 28 mA at 30 V For installation in housing or a switch cabinet with at least IP 30 Temperature range: -10 to +55 °C Dimensions (W x H x D) 106 x 92 x 65 mm (6 TE)	56450001
---------------	---	----------



SLON-DR network adapter

Enables linking of up to three SafeRoute SCU control units to LON networks as well as the visualisation and parametrisation via TMS Soft®. The connection is established on the RS232 interface of the SCU control unit (master). The SLI Basic licence card is the minimum requirement. Length of the RS232 connections max. 15m per interface.

SLON-DR	LON network adapter for mounting on DIN top hat rails 3 COM interfaces COM 1 to COM 3 Power supply 24 V DC ±10% (from the DCW® bus) Power input 55 mA For installation in housing or a switch cabinet with at least IP 30 Temperature range: -10 to +55 °C Dimensions (W x H x D) 106 x 92 x 65 mm (6 TE)	56450011
----------------	--	----------



SLAN-DR network adapter

Enables linking of one of the SafeRoute SCU control units to the LAN TCP/IP network as well as the visualisation and parametrisation via TMS Soft®. The connection is established on the RS232 interface of the SCU control unit (master). The SLI Basic licence card is the minimum requirement. Length of the RS232 connection max. 15m.

SLAN-DR	LAN network adapter for mounting on DIN top hat rails 1 COM interface Power supply 24 V DC ±10% (from the DCW® bus) Power input 60 mA For installation in housing or a switch cabinet with at least IP 30 Temperature range: -10 to +55 °C Dimensions (W x H x D) 106 x 92 x 65 mm (6 TE)	56450021
----------------	--	----------



NT-G lockable metal housing with tamper switch

Housing with integrated two-rowed top hat rail each 15 TE for DR components or USV 24 V DC power supply unit and AP 1224 battery pack, 4 AP 1224 battery packs maximum can be placed in the housing. Class of protection IP 30

NT-G	Lockable metal housing with tamper switch, on-site Europrofile half cylinder in accordance with DIN 18 252 required 230 V AC power supply Dimensions (W x H x D) 305 x 380 x 126 mm	56126300
-------------	---	----------



NT-G1 plastic housing for 2 DR components

Housing with integrated top hat rail, IP 66 class of protection for interior and external mounting.

NT-G1	Tamper-proof plastic housing, prepared with a top hat rail (12 TE) Dimensions (W x H x D) 254 x 180 x 90 mm Including 7 M20 clamping glands for cable bushing	56126301
--------------	--	----------



NT-G2 plastic housing for 6 DR components

Housing with integrated top hat rail, IP 66 class of protection for interior and external mounting.

NT-G2	Tamper-proof plastic housing, prepared with 2 top hat rails (each 18 TE) Dimensions (W x H x D) 360 x 254 x 111 mm Including 12 M20 clamping glands for cable bushing	56126302
--------------	--	----------

SafeRoute components Power supply unit

Planning for power supply unit and DCW® bus wiring

The power supply in a SafeRoute system is supplied via the 24 V DC DCW® bus. The power can be supplied anywhere in the bus via one or more power supply units, depending on the number of components connected. The permitted total length of the bus wiring must not exceed 300 m. For systems in accordance with EN 13637 and EltVTR (German directive for electrical locking systems on escape route doors), a drop in voltage of $\pm 15\%$ and $\pm 10\%$ maximum are respectively permitted.

For the DCW® bus, a J-Y(St)Y 2x2x0.8 mm cable is recommended (\varnothing 0.8 corresponds to a cross-section of 0.5 mm²). For short wiring routes, a J-Y(St)Y 2x2x0.6 mm cable can also be used (\varnothing 0.6 corresponds to a cross-section of 0.34 mm²).



USV-24 3

Power supply unit for mounting on DIN top hat rails, with battery change regulator, 24 V DC $\pm 5\%$, 3 A.

USV-24 3	Input voltage 100–240 V For installation in the NT-G housing, on-site housing or switch cabinet with at least IP 30 Temperature range 0 to +50 °C Dimensions (W x H x D) 210 x 93 x 69 mm (12 TE)	56125150
-----------------	--	----------



AP 1224 battery pack

AP 1224 battery pack for USV-24 3: Battery pack to keep the escape route door functioning in the event of power failure or voltage drop. For installation in the NT-G housing, on-site housing or switch cabinet.

Battery pack AP 1224	2 or 4 units required in combination with USV 24 3 Output voltage 12 V DC Nominal capacity 4.0 Ah	56622400
-----------------------------	---	----------



Cable set 24 V

Cable set for the connection of 2 or 4 battery packs.

Cable set 24 V	Cable set for the connection of 2 or 4 battery packs	56622402
-----------------------	--	----------

**NT 24 5**

Power supply unit for mounting on DIN top hat rails, 24 V DC $\pm 5\%$, 2.5 A.

NT 24 5	Input voltage 100–240 V Output voltage 24 V DC $\pm 5\%$, 2.5 A for installation in housing or a switch cabinet with at least IP 30 Temperature range 0 to +50 °C Dimensions (W x H x D) 72 x 93 x 69 mm (4 TE)	56125100
----------------	--	----------

**RZ-01 with housing**

Power supply unit with LED operating status indicator, 24 V DC $\pm 5\%$, 0.6 A.

RZ-01	Input voltage 230 V AC $\pm 10\%$ Output voltage 24 V DC $\pm 5\%$, 0.6 A Class of protection IP 21 Temperature range 0 to +50 °C Dimensions (W x H x D) 160 x 80 x 62 mm	56332100
--------------	--	----------

**PSU 24 flush-mounted power supply unit**

Switching power supply unit for power supply in accordance with EN 60950 for installation in flush-mounted boxes (62 mm deep).

PSU-24	Switching power supply unit in accordance with EN 60950 Input voltage 230 V AC $\pm 10\%$, 50/60Hz Output voltage 24 V DC Output power 600 mA Dimensions (W x H x D) 51 x 51 x 24 mm (max. diagonal 55 mm)	56030101
---------------	---	----------

**NT 24 V-1.5 with housing**

Power supply unit 24 V DC $\pm 5\%$, 1.5 A.

NT 24 V-1.5	Input voltage 230 V AC $\pm 15\%$ Output voltage 24 V DC $\pm 5\%$, 1.5 A Class of protection IP 21 Temperature range 0° bis +50 °C Dimensions (W x H x D) 200 x 120 x 75 mm	56332100
--------------------	---	----------

SCU-UP – control unit with emergency button for installation into a flush-mounted box



The SCU-UP with emergency button is always used with a key switch (e.g. analogue ST 55 key switch). Together with an electrical locking device, the SCU-UP fulfils the requirements of EN 13637 and EltVTR (German directive for electrical locking systems on escape route doors).

Together with a licence card, the SCU-UP becomes a control and monitoring panel (master). Without an inserted licence card, a SCU-UP can be used as an additional emergency button in an escape route system as a "slave".

Equipment and features

- Illuminated non-locking emergency button
- Integrated 8 segment light ring as status display
- Integrated 4 wire DCW® bus interface
- Integrated sabotage switch
- Integrated alarm siren
- Inputs: up to 4 integrated (depending on the system configuration: 2 via system cable and 2 via terminals). Can be expanded with up to 16 opto-coupler inputs from Standard licence upwards
- Outputs: 2 integrated (via terminals, GND switching). Can be expanded with up to 16 floating outputs from Standard licence upwards
- Use of automatic alarm acknowledgement in accordance with EN 13637 possible (depending on licence)
- Connection possibilities for analogue ST 55 key switch (from SLI Basic licence card upwards, further DCW® key switches possible)
- Range of functions depends on the selected licence and application card
- Functions can be freely configured with TMS Soft® (from SLI Basic licence card upwards)

Colour variants and additional components

The SCU-UP control unit with emergency button is available in three colour variants. With further SafeRoute components, door terminals can be assembled based on individual requirements, e.g. backlit SES-UP escape route symbol (only in accordance with EN 13637) or STD-UP touchscreen display, code keyboard as access control and as "down counter" for delayed release. The most popular combinations are also available as supply sets (Page 30).

SCU-UP emergency button/control unit

SCU-UP control unit with emergency button for installation in flush-mounted boxes (minimum depth 42 mm, recommended depth 62 mm)

		Order no.
SCU-UP W	White	56411100
SCU-UP S	Silver	56411101
SCU-UP A	Anthracite	56411115

SCU-UP connection possibilities and possible accessories depending on licence card	SLI Mini	SLI Basic	SLI Standard	SLI Premium
ST 55 key switch	○	●	●	●
Analogue				
Input 1: "Static drive" default	○	●	●	●
Input 2: "Fire or smoke detection system" default	○	●	●	●
Output 1: "Locked" default	○	●	●	●
Output 2: "General alarm (alarm signal)" default	○	●	●	●
DCW® bus interface				
Max. 4 STV 1xx, STV 2xx, STV 5xx, STV-ETS electric locking devices (for connecting dormakaba turnstiles) or STV-A adapter (for analogue dormakaba door locking devices or for integration of foreign products with analogue switch contacts without DCWR bus interface; certifications in accordance with EltVTR or EN 13637 must be observed)	○	○	○	○
SVP 2xxx DCW®, M-SVP 22xx DCW®, motorised emergency escape locks for increased protection against break-in (up to RC4) and with automatic doors	-	●	●	●
I/O module DCW® additional module with 4 analogue inputs and outputs for integrating sensors/actuators	-	-	●	●
ST 3x DCW®, ST 55 DCW® LED, max. 4 additional key switches	-	●	●	●
SCU-UP or SCU-TL (without licence card) as "slave", emergency button with ST connection 1, max. 4 more SCUs	-	●	●	●
- as bi-directional escape route	-	■	■	●
- as airlock or multi-door system	-	■	■	●
STD-UP touchscreen display (max. 4)	-	■	■	●
- as "down counter" for delayed release	-	-	●	●
- as access control with code keypad	-	-	●	●
RMZ DCW®, smoke detector/smoke detector with integrated power pack	-	○	○	○
RS232 interface				
LON/LAN adapter SLON-UP, SLON-DR, SLAN-DR	-	○	●	●
Parametrisation via TMS Soft®	-	●	●	●
Central Management Control				
As per license model with LON/LAN networking (see page 13)	-	-	-	●

- Not available ○ Available, not configurable ● Available and configurable ■ With application

SCU-UP technical data

Power supply via DCW® bus 24 V DC ±10%	
Power input	Closed-circuit current 65 mA In case of alarm 100 mA
Class of protection	IP 32
Temperature range	-10 °C to +55 °C



Direct link to the specification text
www.dormakaba.com/saferoute/downloads

Terminal supply sets for installation in flush-mounted boxes

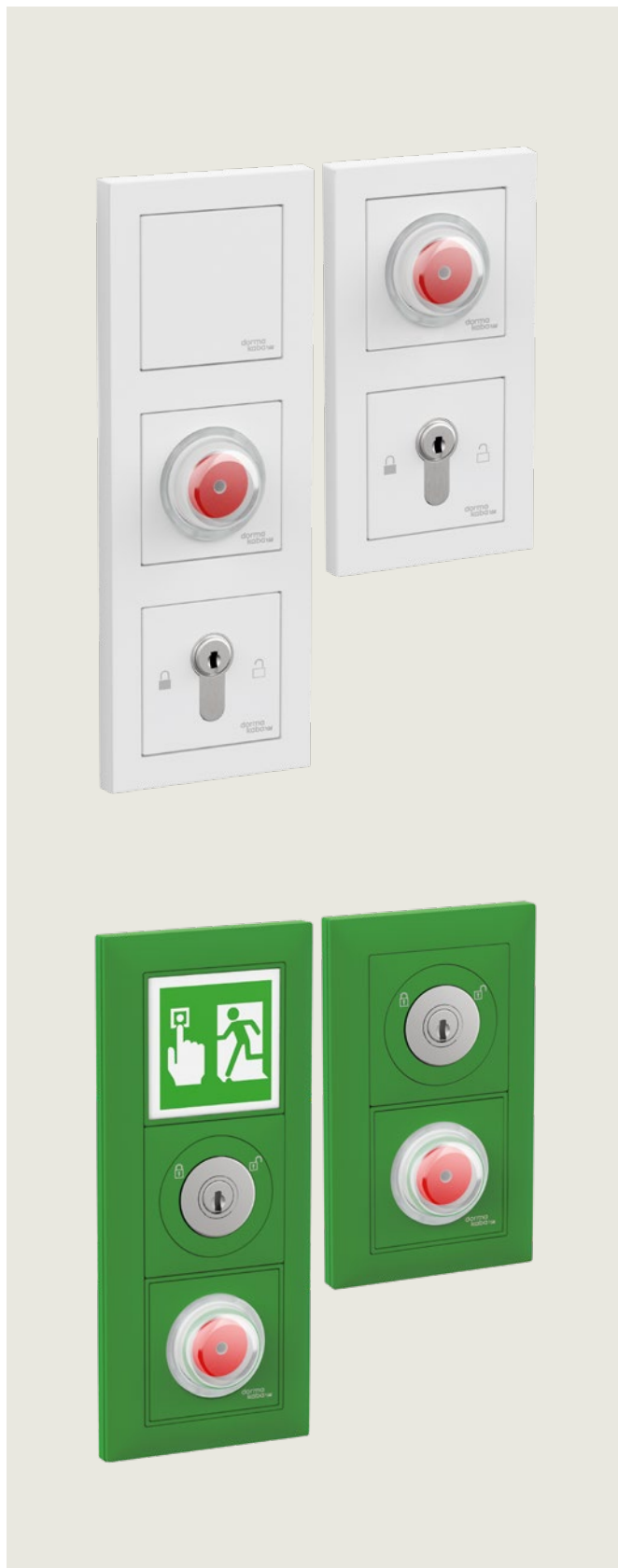

The terminal supply set consists of the SCU-UP components with emergency button and a key switch (ST) for installation in flush-mounted boxes. Together with an electrical locking device, the installation sets fulfil the requirements of EN 13637 and EltVTR (German directive for electrical locking systems on escape route doors).

Together with a licence card, the terminal becomes a control and monitoring panel (master). Without a licence card, the terminal can also be used as an additional door terminal for an escape route door as a "slave" in a group.

Equipment and features

- Inputs: up to 4 integrated (depending on the system configuration: 2 via system cable and 2 via terminals). Outputs: 2 integrated (via terminals, GND switching). Can be expanded with up to 16 floating outputs from Standard licence upwards
- Integrated sabotage switch
- Backlit, non-locking emergency button – automatic alarm acknowledgement if the escape route door has not been opened (only permitted under EN 13637 and depends on licence)
- 8 segment light ring as status display
- Integrated alarm siren and visual alarm indication
- Key switch for alarm acknowledgement, locking and unlocking with holder for 30/10 half cylinder, e.g. dormakaba penta
- Range of functions depends on the selected licence and application card
- Functions can be freely configured with TMS Soft® (from SLI Basic licence card upwards)
- Easy wiring and reliable operation thanks to DCW® bus technology
- SCU-UP supply sets System 55 for profile cylinders available (see page 31)
- STL-UP supply sets in Feller Edizio design for Swiss round cylinders available (see page 32)

Direct link to the specification text
www.dormakaba.com/saferoute/downloads





3-item SCU-UP supply set with emergency button, ST 55 key switch and PSU-24 power supply unit

Door terminal set comprising of SCU-UP control unit/emergency button and TL-ST S55 key switch as flush-mounted inserts for System 55, as well as double-type cover frames, lock cylinder is not included in supplied package, incl. flush-mounted PSU-24 power supply unit.

SCU-UP technical data

Power input approx. 65 mA in close-circuit current, approx. 100 mA in case of alarm
Class of protection IP 32
Temperature range -10 to +55 °C rel. Humidity 93% (non-condensing)

PSU-24 power supply unit technical data

Input voltage 230 V AC ±10%, 50/60Hz
Output voltage 24 V DC
Output power 600 mA
Observe maximum output current. With long cable lengths or many bus devices, supply voltage from multiple feeds may be needed, e.g. to STV door locking devices.

		Order no.
SCU-UP NT Set S55 E2W	White	56423000
SCU-UP NT Set S55 E2S	Silver	56423001
SCU-UP NT Set S55 E2A	Anthracite	56423002

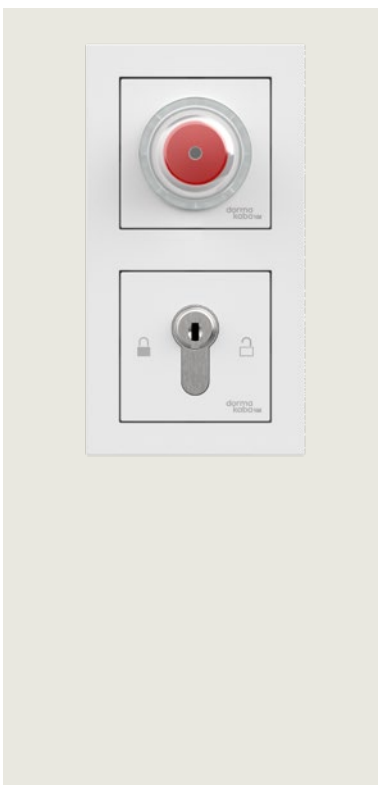

2-item SCU-UP supply set with emergency button and ST 55 key switch

Door terminal set comprising of SCU-UP control unit/emergency button and TL-ST S55 key switch as flush-mounted inserts for System 55, as well as double-type cover frames, lock cylinder is not included in supplied package.

Power supply 24 V DC via DCW® bus

Power input approx. 65 mA in closed-circuit current, approx. 100 mA in case of alarm
Class of protection IP 32
Temperature range -10 to +55 °C rel. Humidity 93% (non-condensing)

		Order no.
SCU-UP Set S55 E2W	White	56422000
SCU-UP Set S55 E2S	Silver	56422001
SCU-UP Set S55 E2A	Anthracite	56422002

Terminal supply sets in Feller Edizio design

Only available in Switzerland via dormakaba Switzerland Ltd



Verification of suitability EltVTR

EN 13637



Verification of suitability EltVTR

EN 13637

STL-UP F22 and STL-UP F32 SES supply sets **NEW**

Door terminal sets for installation in double or triple-type device boxes (min. depth 48 mm).

Both the sets are suited for plugging in an SLI licence card for use as a Safe-Route control unit (master) or for use without a licence card as an additional emergency button (slave). Connection via DCW® system bus. 24 V DC power supply via external dormakaba power supply unit, via DCW® system bus or via 24 V DC on site.

Power supply:	via DCW® bus 24 V DC +/-10%
Power input:	Closed-circuit current 65 mA, in case of alarm 100 mA
Power input with illuminated emergency exit sign:	Closed-circuit current max. 125 mA, during alarm max. 160 mA.
Ambient temperature:	-10 °C to +55 °C
Class of protection:	IP32 (illuminated emergency exit sign IP30)
Rel. Humidity:	93% (non-condensing)

Double-type supply set

Door terminal set consisting of control unit/SCU-UP emergency button and TL-ST key switch for on-site key switch cylinders (e.g. dormakaba 1007F) pre-installed on base plate with Feller Edizio double-type cover frame.

STL-UP F22	Signal green	Edizio due	2041088
-------------------	--------------	------------	---------

Triple-type supply set with illuminated emergency exit sign

Door terminal set consisting of control unit/SCU-UP emergency button, TL-ST key switch for on-site key switch cylinders (e.g. dormakaba 1007F) and illuminated emergency exit sign SES-UP as per EN 13637, pre-installed on base plate with Feller Edizio triple-type cover frame.

STL-UP F32 SES	Signal green	Edizio due	2041089
-----------------------	--------------	------------	---------

ST key switches

ST key switch for the unlocking and locking of doors in the SafeRoute emergency exit and escape route system and for resetting an alarm. Up to three functions can be switched. The range of functions is dependent on the inserted licence card in the SCU control and monitoring centre (master).

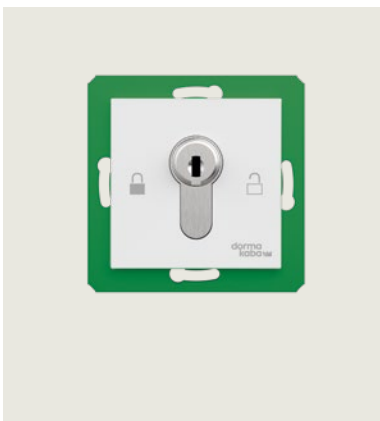

ST 55

For connection to SCU-UP, incl. pre-assembled connection cable to the SCU-UP, manipulation-proof, prepared for installation of a 30/10 profile half cylinder. Power supply via SCU-UP Class of protection IP 32 Temperature range -10 to +55 °C rel. Humidity 93% (non-condensing)

		Order no.
ST 55 W	White	56330510
ST 55 S	Silver	56330501
ST 55 A	Anthracite	56330515

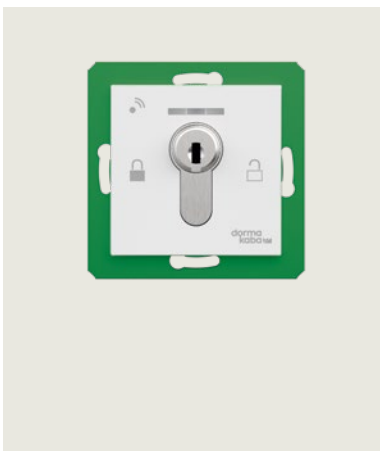

ST 55 DCW® LED

For connection to the DCW® bus, with multi-colour status display and feed sensor integrated in the cover, manipulation-proof, prepared for installation of a 30/10 profile half cylinder. Power supply via DCW® bus Power input: approx. 20 mA in closed-circuit current, approx. 50 mA in case of alarm Class of protection IP 30 Temperature range -10 to +55 °C rel. Humidity 93% (non-condensing)

		Order no.
ST 55 DCW® LED W	White	56330910
ST 55 DCW® LED S	Silver	56330901
ST 55 DCW® LED A	Anthracite	56330915



ST 3x DCW® in light metal housing

Key switch in manipulation-proof version with LED display (red/green), silver LM housing with front plate, suitable for surface-mounted and flush-mounted installation, prepared for installation of a 30/10 half cylinder. Power supply via DCW® bus Current consumption approx. 20 mA in closed-circuit current Class of protection IP 30 Temperature range -10 to +55 °C rel. Humidity 93% (non-condensing) Housing dimensions (W x H x D) approx. 75 x 75 x 50 mm, Front plate (flush-mounted installation) 90 x 100 x 2 mm

		Order no.
ST 32 DCW®	Prepared for 30/10 profile half cylinder	56343200
ST 34 DCW®	Prepared for 30/10 round half cylinder	56343400

Additional components

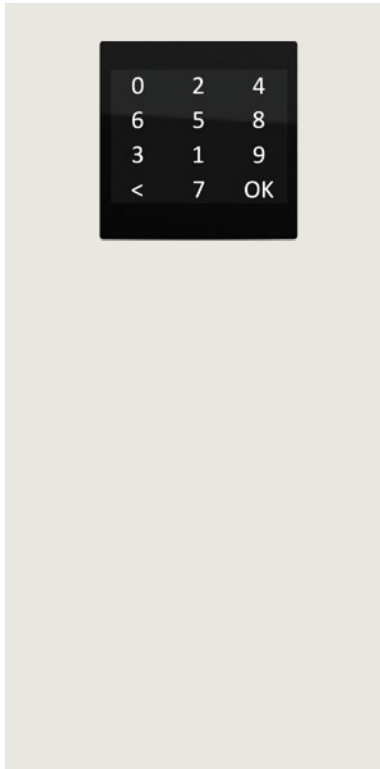

STD-UP touchscreen display DCW®

The STD-UP touchscreen display for installation in flush-mounted boxes (62 mm deep) in accordance with DIN as a System 55 GIRA application. When using other frame systems, consider a flush finish with the control surface. The range of functions depends on the chosen licence and application card in the SCU control unit (master).

- Control and display functions for SafeRoute systems
- Down counter display for emergency opening delay (time-delayed release in accordance with EN 13637) from SLI Basic licence card upwards and SLI-A application card time-delayed release (special approval necessary)
- Code keypad with randomly changing keypad layout and access control (from SLI Standard licence card upwards, maximum 20 different PIN codes)
- Adjustable brightness and configurable energy saving mode
- Easy set-up and reliable operation thanks to DCW® bus technology

STD-UP DCW®	Touchscreen display Power supply 24 V DC via DCW® bus Power input approx. 40 mA Class of protection IP 30 Temperature range: -10 to +55 °C Dimensions (H x W x D) 55 x 55 x 24 mm	56490200
--------------------	--	----------

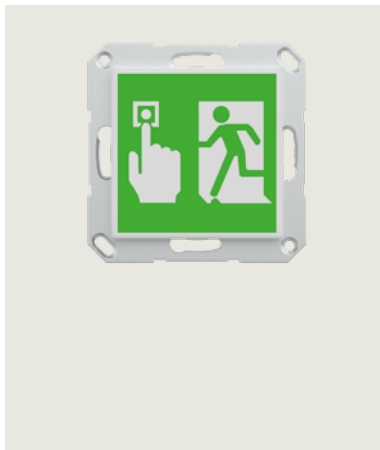

SES-UP backlit escape route sign in accordance with EN 13637

Backlit escape route symbol for installation in flush-mounted boxes (62 mm deep) in accordance with DIN as a System 55 application

- Active lighting with 4 LEDs (warm white)
- Replaceable pictogram inserts for systems with and without a time delay

SES-UP	Backlit escape route symbol, power supply 24 V DC ±15%, stabilised Power input max. 60 mA Class of protection IP 30 Temperature range -10 to +55 °C	56490220
---------------	--	----------



S 55 UP siren

Multi-function siren for installation in flush-mounted boxes (62 mm deep) in accordance with DIN. 28 programmable tone types with DIN tone, adjustable volume up to 107 dB/A maximum at 1 m. International emergency signal for evacuation with three pierced System 55 covers in white, silver and anthracite.

S 55 UP siren	24 V DC power supply Power input 5–35 mA depending on tone frequency Class of protection IP 54 Temperature range: –40 to +80 °C	56330730
----------------------	--	----------



SLON-UP network adapter

The SLON-UP network adapter enables the connection of up to 2 SafeRoute SCU control units to a LON network. The SLON-UP network adapter is in accordance with DIN for installation in flush-mounted boxes (62 mm deep). The connection is established on the RS232 interface of the SCU control unit (master). The SLI Basic licence card is the minimum requirement.

SLON UP	LON network adapter Power supply 24 V ±15% Power input approx. 30 mA Class of protection IP 20 Temperature range –10 to +55 °C rel. Humidity 93% (non-condensing) Interfaces COM 1 and COM 2	56450012
----------------	--	----------



DCW® UP I/O module

Bus coupler module for connecting products with analogue switch contacts to SafeRoute via the dormakaba DCW® bus.

3 opto-coupler inputs (interface connection with signals from 5 to 30 V AC/DC) for external actuator control. 2 outputs for control of external components. Individual requirements can be freely configured with TMS Soft® from Version 5.0 upwards (depending on licence).

Supply with 3 end caps for System 55 in white, silver and anthracite.

DCW® UP I/O module	Installation in standard device boxes (62 mm deep) in accordance with DIN Power supply 24 V DC via DCW® bus Power input max. 60 mA Maximum load current for relay outputs 45 V DC/35 V AC, 2 A Recommended cable J-Y(St)Y 2 x 2 x 0.6 mm	19357100
---------------------------	---	----------

Additional components



DCW® I/O module

Bus coupler module for connecting products with analogue switch contacts to SafeRoute via the dormakaba DCW® bus.

4 opto-coupler inputs (interface connection with signals from 5 to 30 V AC/DC) for external actuator control. 4 floating outputs for control of external components. Individual requirements can be freely configured with TMS Soft® from Version 5.0 upwards (depending on licence).

DCW® UP I/O module	Power supply 24 V DC via DCW® bus Power input max. 45 mA Power per opto-coupler input: <ul style="list-style-type: none"> • 2.8 mA at 5 V: • 8 mA at 12 V • 17 mA at 24 V • 28 mA at 30 V Maximum load current for relay outputs 24 V DC/1 A Recommended cable J-Y(St)Y 2 x 2 x 0.6 mm	19357100
---------------------------	--	----------

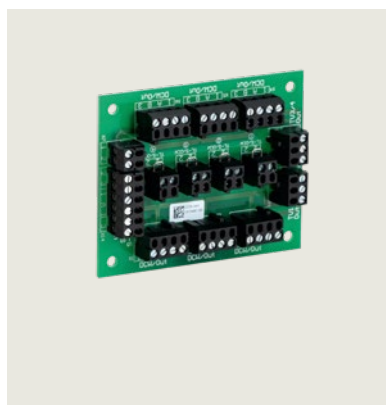

DCW® bus distributor circuit board

DCW® bus distributor as branching circuit board for DCW® bus device for the DCW® bus, for installation in DCW® distributor housing or customer's own housing

DCW® Bus distributor	Dimensions 75 x 60 x 15 mm	56352100
-----------------------------	----------------------------	----------



DCW® distributor housing

DCW® distributor housing IP 54 for installation of up to 4 bus devices and/or DCW® I/O modules.

DCW® Distributor housing	Dimensions 200 x 120 x 75 mm	56352000
---------------------------------	------------------------------	----------



BL 01 flashing light

Green flashing light in impact-resistant ABS housing, for horizontal mounting. Approx. 80 flashes/minute

BL 01	24 V DC power supply	56330730
Flashing light	Power input max. 250 mA	
	Class of protection IP 54	
	Temperature range -20 to +50 °C	
	Dimensions Ø 108 mm, Height 133 mm	



AS 01 siren

Multi-function siren for wall mounting in accordance with DIN. 28 programmable tone types with DIN tone, adjustable volume up to 98 dB/A maximum at 1 m. International emergency signal for evacuation.

AS 01 siren	24 V DC power supply	56080100
	Power input max. 32 mA depending on tone frequency	
	Class of protection IP 65	
	Dimensions Ø 93 mm, Height 102 mm	
	Temperature range -20 to +50 °C	

SLI licence cards

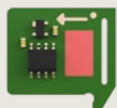

Together with an SLI licence card, an SCU becomes a control and monitoring panel (master). The scope of functions is determined based on the respective licence card. The SLI-A application cards enable the expansion of special functions.

SLI Mini (red)

The SLI Mini licence card is sufficient for setting up a simple escape route door with pre-configured parameters.

Functions

- Release via emergency button and alarm system (analogue input signal, e.g. smoke detector etc.)
- Authorised access with key switch (short-term and permanent unlocking) with audible confirmation upon activating permanent door release
- Automatic re-locking following short-term unlocking
- Automatic re-activation following power failure
- Reset of release mode via key/emergency button
- Open door monitoring with pre-alarm/main alarm if door is not re-locked.
- Tampering monitoring
- Maintenance alarm (with outstanding maintenance 11 months after commissioning)
- Access from outside, e.g. via an on-site access control system, possible

Connection possibilities via DCW® bus interface: maximum 4 STV 1xx, STV 2xx, STV 5xx electric door locking devices, or via STV-A adapter dormakaba door locking devices and foreign products with analogue switch contacts (certifications in accordance with EltVTR or EN 13637 must be observed) without DCW® bus interface

SLI Basic (yellow)

With the SLI Basic licence card, the escape route door can be expanded in terms of security and convenience. With SLI-A applications that can be loaded, the SCU can be expanded for other functions.

Functions

The SLI Basic licence card has the same range of functions as SLI Mini and in addition offers the following functions

- Freely programmable inputs and outputs Analogue connection possibilities stem from result from the selected SCU (SCU-UP/SCU-TL/SCU-DR).
- Functions of the internal key switch freely configurable
- Setting brightness of light ring
- Automatic release acknowledgement in accordance with EN 13637 (if the door has not been opened within 60 seconds)
- Networking via LON and LAN network (with optional LON or LAN adapter)
- Visualisation, control and parametrisation via TMS Soft® (with interface to superordinate building management systems)
- Tableau technology via LON/LAN
 - with TE25 central unlocking/locking as well as locking the control function in SCMC 80
 - Visualise and control with SCMC 80
- Function extension possible with application cards:
 - Multi-door application for securing up to four self-sufficient, individually operable doors with just one control unit (master)
 - Airlock application (contains multi-door application) for developing airlocks with up to four doors with one control panel (master)
 - Delayed release t1 application for delaying release after activating emergency button for up to 15 seconds, in accordance with EN 13637

Connection of additional DCW® components:

DCW® key switch, RMZ

DCW® smoke detector with integrated power pack, SVP 2000

DCW® motorised emergency escape lock, M-SVP 2200

DCW® multipoint emergency escape locking system, STD-UP touchscreen display. Per component type, up to four devices can be connected (e.g. four STV door locking devices and four DCW® key switches etc.).

SLI Mini Licence card 56412000

SLI Basic Licence card 56412001



SLI Standard (white)

With the SLI Standard licence card, all functions in an SCU are fully configurable. In addition, the use of all DCW® hardware components incl. I/O modules is possible.

Functions

The SLI Standard licence card has the same range of functions as SLI Basic and in addition offers the following functions

- Short and long-term unlocking with configurable relocking time
 - Permanent door release
 - Operating time for triggering the long-term/permanent unlocking modes configurable
 - Combi-function of short-term, long-term and permanent unlocking with optional deactivation of an unlocking mode
- Open door monitoring can be configured (time until pre-alarm/main alarm and duration of alarm)
- Maintenance alarm can be configured
- Alarm management (activation/deactivation of alarms)
- Setting flashing frequency on light ring
- Integrated real-time clock with time switch (parametrisation for special days, public holidays, vacation periods etc. possible)
- Historical memory with date/time stamp
- Access control via code keypad (up to 20 PIN codes per system door) with STD-UP touchscreen display
- Additional expansion of functions with all accompanying application cards possible, plus:
 - Logic application for defining logic functions for inputs and outputs of the common logics, e.g. AND logic, NAND logic, OR logic etc.

Connection of further DCW® components: all DCW® hardware components incl. I/O modules

SLI Premium (light green)

With the SLI Premium license card, all functions and control options of an SCU are available incl. the applications multi-door control, airlock, logic and activation delay T1. Additionally, the escape route door can be monitored and controlled with the Central Management Control (SCMC) panels.

Functions

The SLI Premium license card has the same scope of function as SLI Standard and it additionally offers the following functions

- Multi-door control or airlock control: With an SCU as master, up to 4 doors can be controlled and monitored independent or dependent of each other. The system cabling is done in DCW® bus. Only one network adapter (LON/LAN) is required to network up to 4 doors.
- Logic functions for implementing complex controls. All the analogue inputs and outputs as well as most of the DCW® bus participants can be linked to each other.
 - AND logic. Example: Signal on output 1 will be switched if there is a signal at input 1 and input 2.
 - NAND logic. Example: Signal on output 1 will be switched if there is no signal at input 1 and/or input 2.
 - OR logic. Example: Signal on output 1 will be switched if there is a signal at input 1 or input 2.
 - MEMORY logic: Incoming set/reset signals can be directly or inversely connected with functions.
- Time-delayed activation T1: EN 13637 allows a delayed activation after pressing the emergency button. The locking element is not released immediately, rather it remains continuously locked for the time t1. During the delay period, the alarm is already active. The delay is shown in the SCU's integrated light ring and can additionally be displayed as "down counter" in plain text via the STD touchscreen display.
- Control and monitoring with the panels SCMC20, SCMC30, SCMC40 and SCMC80

SLI-A application cards

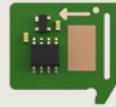
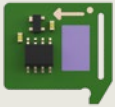

The SLI-A application cards add special features to the escape route doors. For example, 4 doors can be controlled and operated independent of each other with only one license card in DCW® bus.

SLI-A multi-door control (light purple)

With just a single SCU as master, up to four doors can be controlled and monitored independent of one another. The system wiring is made in the DCW® bus. For networking of up to four doors, only one network adapter (LON/LAN) is required.

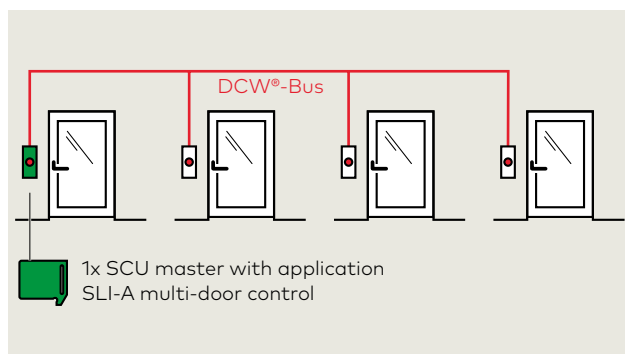

SLI-A multi-door control Application card 56412100

SLI-A airlock control (light brown)

The SLI-A airlock includes all functions for the SLI-A multi-door control. With just a single SCU as master, up to four doors can be controlled and monitored as an airlock group. The system wiring is made in the DCW® bus.

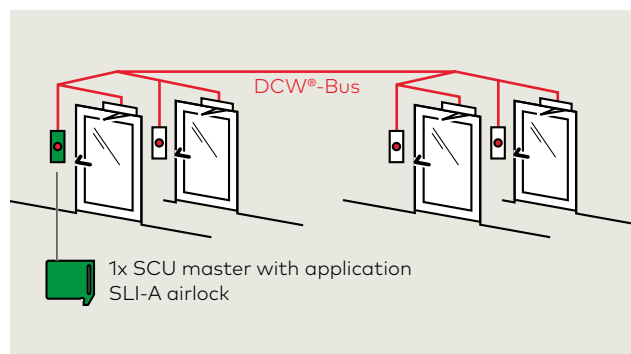

SLI-A airlock control unit Application card 56412101

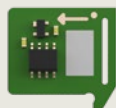
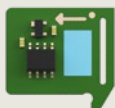

SLI-A logic functions (light blue)

Complex control unit requirements can be implemented with the logic functions. All the analogue inputs and outputs as well as most of the DCW[®] bus participants can be linked to each other.

- AND logic. Example: Signal on output 1 will be switched if there is a signal at input 1 and input 2.
- NAND logic. Example: Signal on output 1 will be switched if there is no signal at input 1 and/or input 2.
- OR logic. Example: Signal on output 1 will be switched if there is a signal at input 1 or input 2.
- MEMORY logic: Incoming set/reset signals can be directly or inversely connected with functions.
- CONNECTOR logic: Incoming or internal signals are forwarded (linked) via a single output.
- PULSE SWITCH logic. Example: Signal (pulse) on input 1 alternately switches output 1 and output 2

SLI-A time-delayed release T1 (light grey)

EN 13637 allows a delayed release after pressing the emergency button. The locking element is not released immediately, rather it remains continuously locked for the time t_1 . During the delay period, the alarm is already active. The delay is shown in the SCU's integrated light ring and can additionally be displayed as a "down counter" in plain text via the STD touchscreen display.

STV 1xx – electromechanical door locking device for lintel mounting

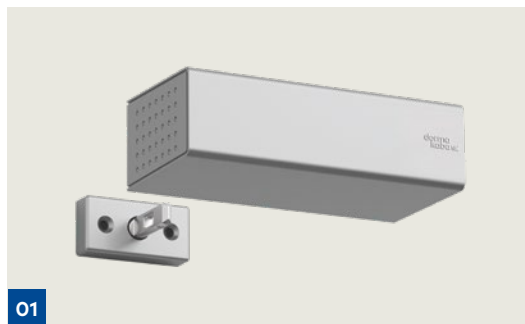

01

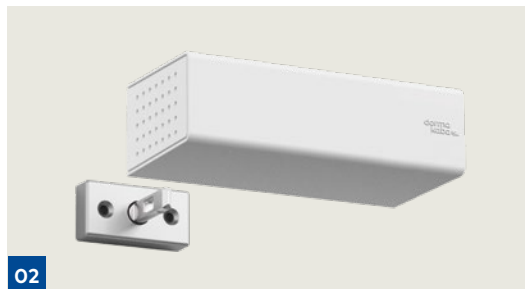

02

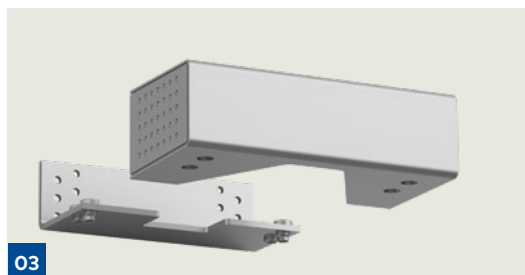

03



04



05

Electromechanical door locking device (closed-circuit current principle) for attaching to the frame lintel. Connection to the SCU exclusively via 4-wire DCW® bus. The STV 1xx door locking system opens without jamming and without delay. The maximum keep-closed force corresponds to EltVTR (German directive for electrical locking systems on escape route doors) and EN 13637 Class 3.

- Integrated contacts for monitoring the active/inactive status
- Protected from manipulation via tamper switch
- Robust coated metal housing
- Easy set-up and reliable operation thanks to 4-wire DCW® bus technology
- Mounting on flush-mounted doors with optional TV-Z mounts

STV 1xx door locking device

Delivery includes holder, shim plate set and hardware bag.

Power supply via DCW® bus, power input 280 mA, class of protection IP 32, temperature range 10 to +55 °C, rel. Humidity 93% (non-condensing) For installation outdoors, weatherproofing is absolutely necessary.

Dimensions (W x H x D) approx. 190 x 58 x 87 mm

Order no.

01 STV 101	Silver	56442101
02 STV 111	White	56442111
03 TV-Z 101	Mount for door locking device STV 100 and STV 200 for flush mounting Dimensions (W x H x D) approx. 190 x 58 x 87 mm Silver	56522201
TV-Z 111	White (like TV-Z 101)	56522211
04 TV-Z 01	Shim plate set for adjusting the mount for door locking device STV 1xx DCW® at rough installation tolerances. 2 items 1 mm thick, 1 item 3 mm thick.	56520101
05 TV-Z 015	Mounting unit for installation of door locking devices STV 100 and STV 200 on slim steel and wooden frames. Galvanised steel plate. Dimensions (W x H x D) approx. 190 x 5 x 80 mm	56520015

F Certificate of suitability

Installation on fire and smoke doors is only allowed if the usability certificates for these doors and their requirements are observed. Country-specific regulations must be observed.

STV 1xx installation in the jamb,
opening outwards

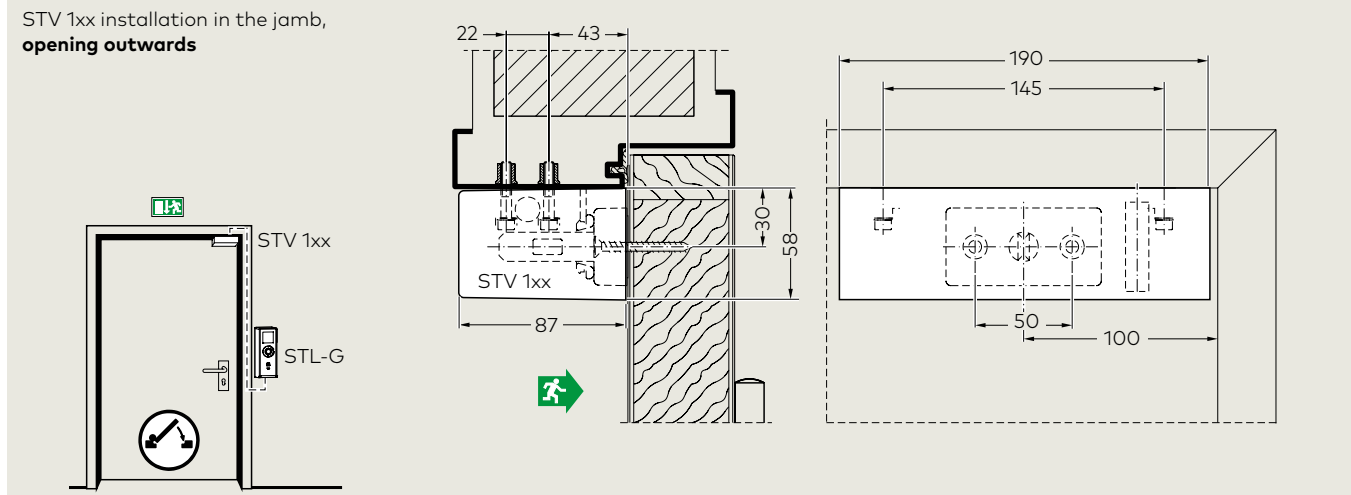

Installation on flush-mounted doors via TV-Z on the frame, **opening outwards**

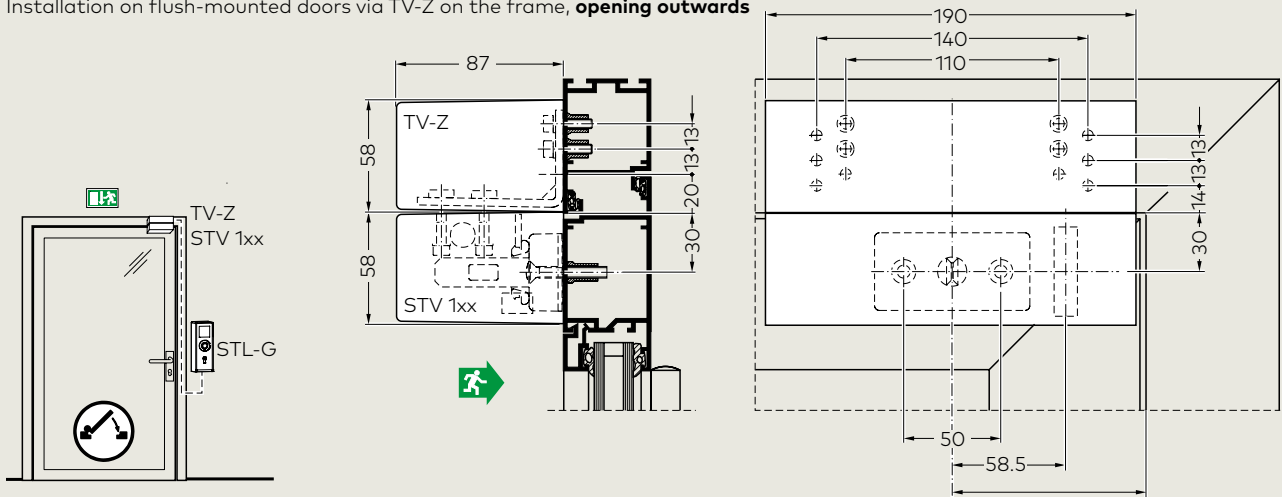

Installation on flush-mounted doors via TV-Z on the outer door, without restriction of the clear passage height, **opening outwards**

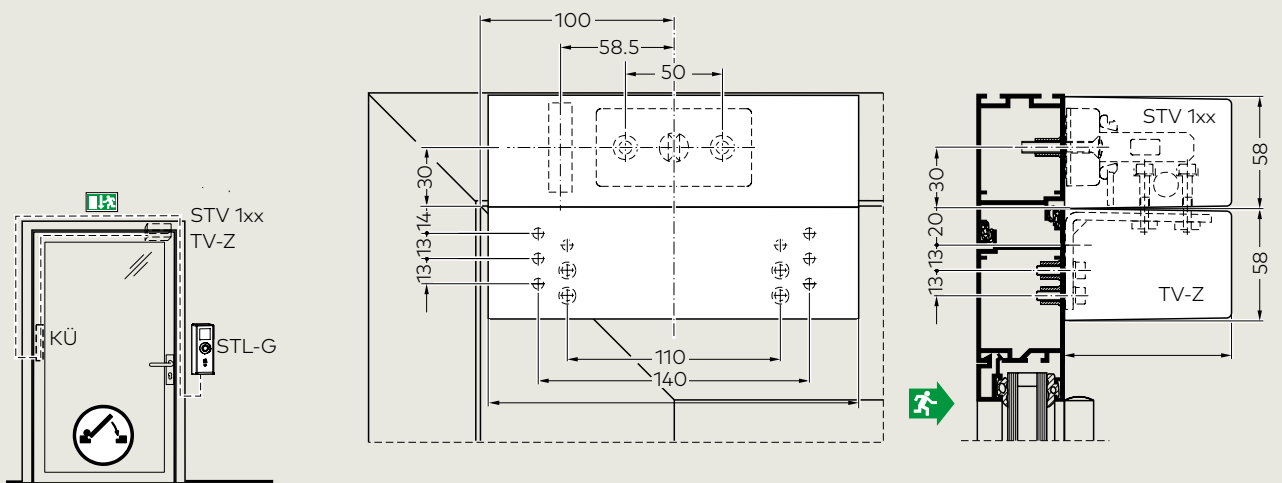

Installation on flush-mounted doors via TV-Z on the door, without restriction of the clear passage height, **opening inwards**

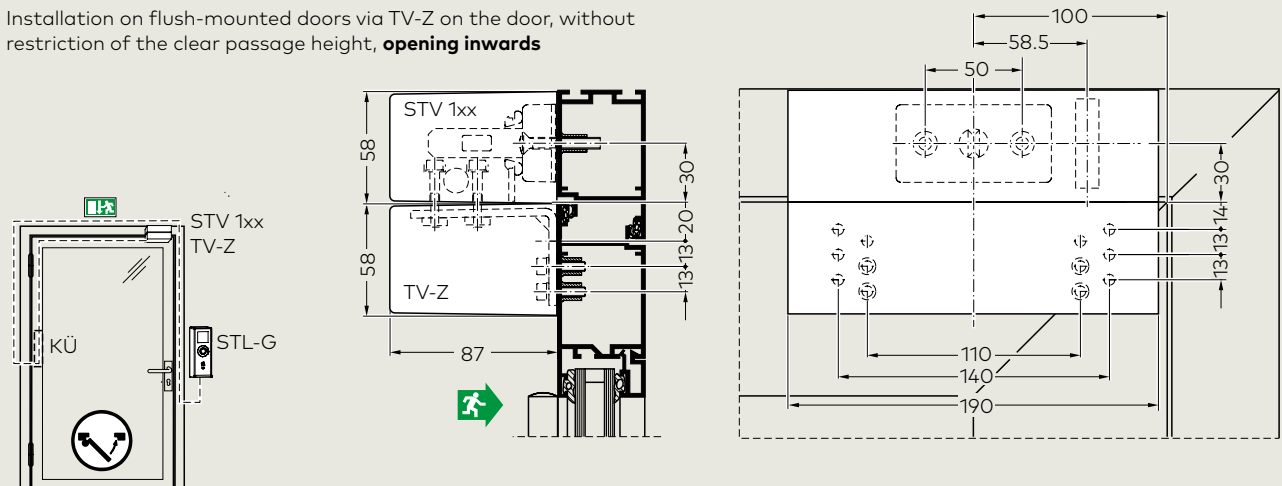

STV 2xx – electromagnetic door locking device for lintel mounting

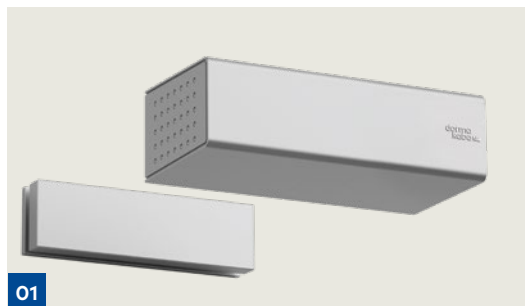

01

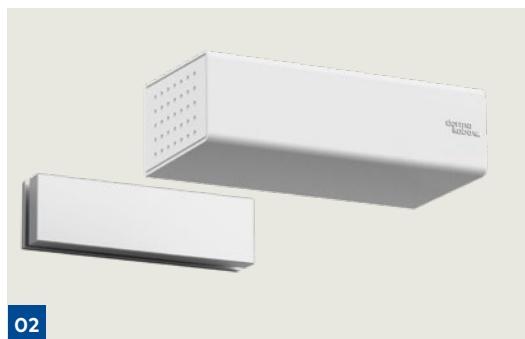

02

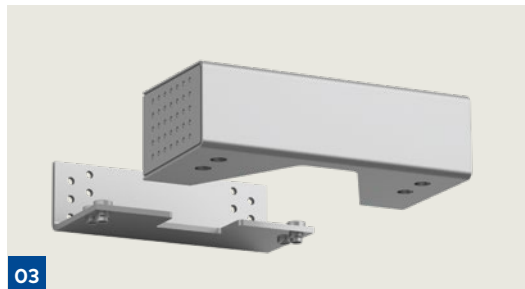

03

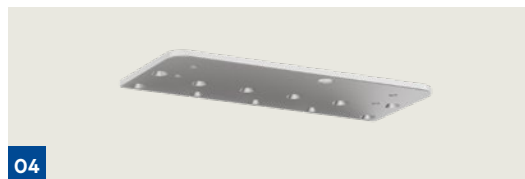

04

Electromagnetic door locking device (closed-circuit current principle) for attaching to the frame lintel. Connection to the SCU exclusively via 4-wire DCW® bus. The STV 2xx door locking system opens without jamming and without delay. The maximum keep-closed force corresponds to EltVTR (German directive for electrical locking systems on escape route doors) and EN 13637 Class 3.

- Integrated contacts for monitoring the active/inactive status
- Protected from manipulation via tamper switch
- Robust coated metal housing
- Easy set-up with three-dimensional adjustability and reliable operation thanks to 4-wire DCW® bus technology
- Mounting on flush-mounted doors with optional TV-Z mounts

STV 2xx door locking device

Delivery includes counter-plate and mounting material.

Power supply via DCW® bus, Power input max. 200 mA, maximum load current 24 V DC, 500 mA inductive, 24 V DC, 1.0 A ohmic, class of protection IP 32, temperature range -10 to +55 °C rel. Humidity 93% (non-condensing) For installation outdoors, weatherproofing is absolutely necessary.

Dimensions (W x H x D) approx. 190 x 58 x 87 mm

Order no.

01 STV 201	Silver	56442201
02 STV 211	White	56442211
03 TV-Z 101	Mount for door locking device STV 100 and STV 200 for flush mounting Dimensions (W x H x D) approx. 190 x 58 x 87 mm Silver	56522201
TV-Z 111	White (like TV-Z 101)	56522211
04 TV-Z 015	Mounting unit for installation of door locking devices STV 100 and STV 200 on slim steel and wooden frames. Galvanised steel plate. Dimensions (W x H x D) approx. 190 x 5 x 80 mm	56520015

F Certificate of suitability

Installation on fire and smoke doors is only allowed if the usability certificates for these doors and their requirements are observed. Country-specific regulations must be observed.

STV 2xx installation in the jamb, opening outwards

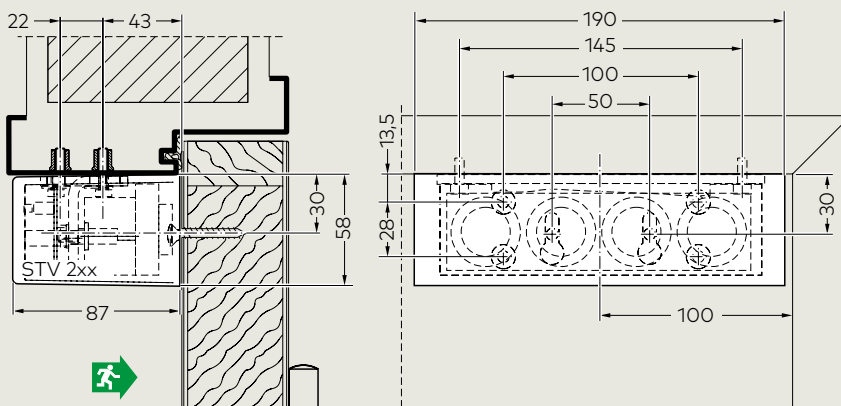
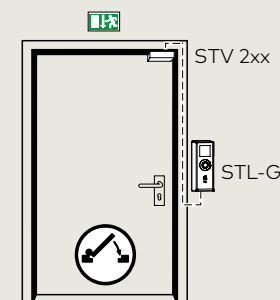

Installation on flush-mounted doors via TV-Z on the frame, **opening outwards**

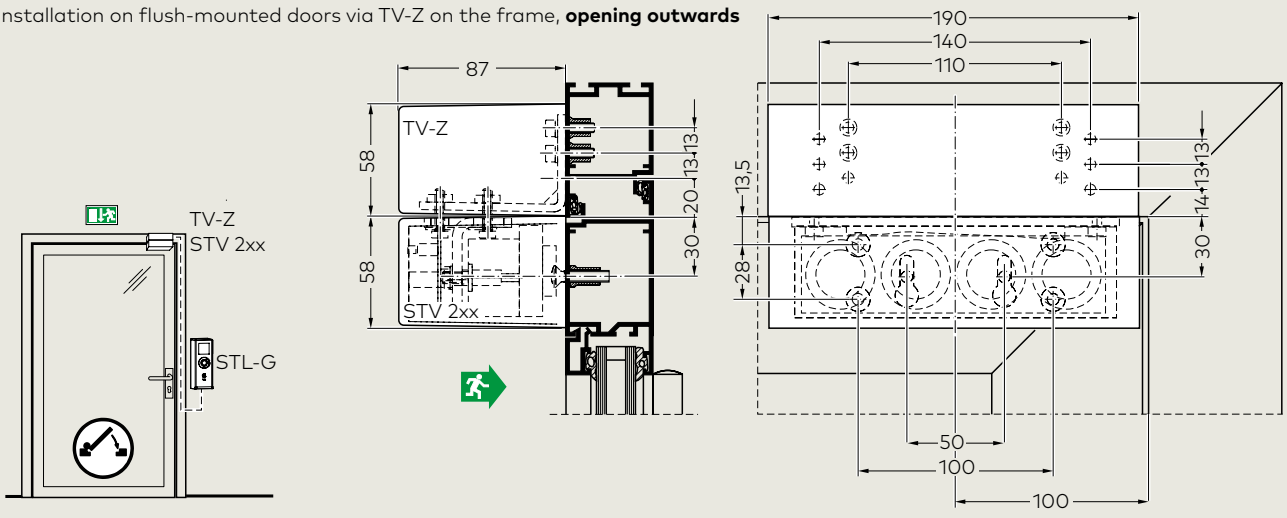

Installation on flush-mounted doors via TV-Z on the outer door, without restriction of the clear passage height, **opening outwards**

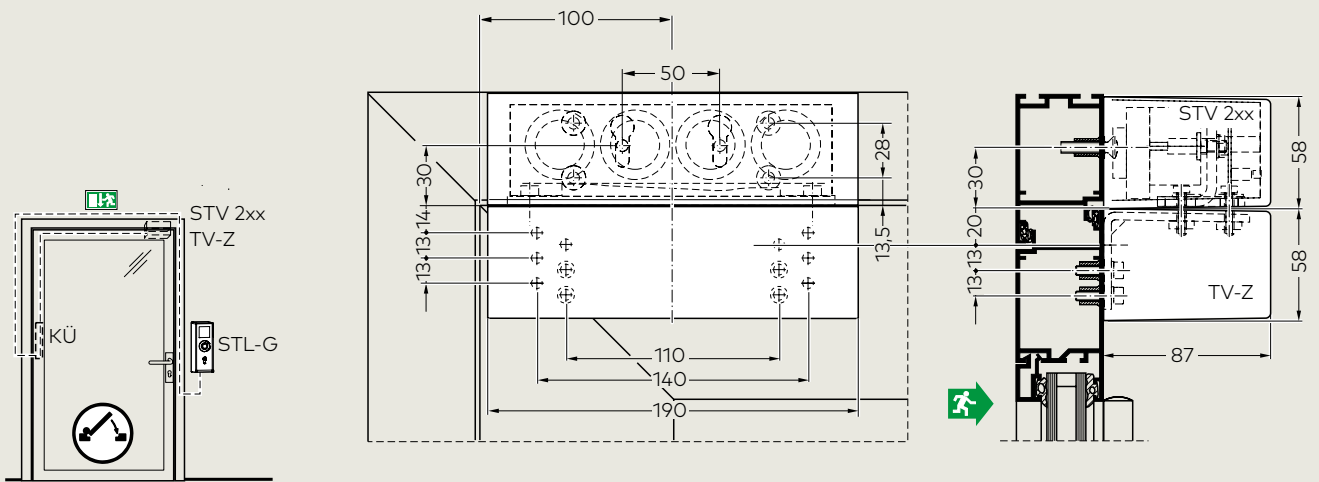

Installation on flush-mounted doors via TV-Z on the door, without restriction of the clear passage height, **opening inwards**

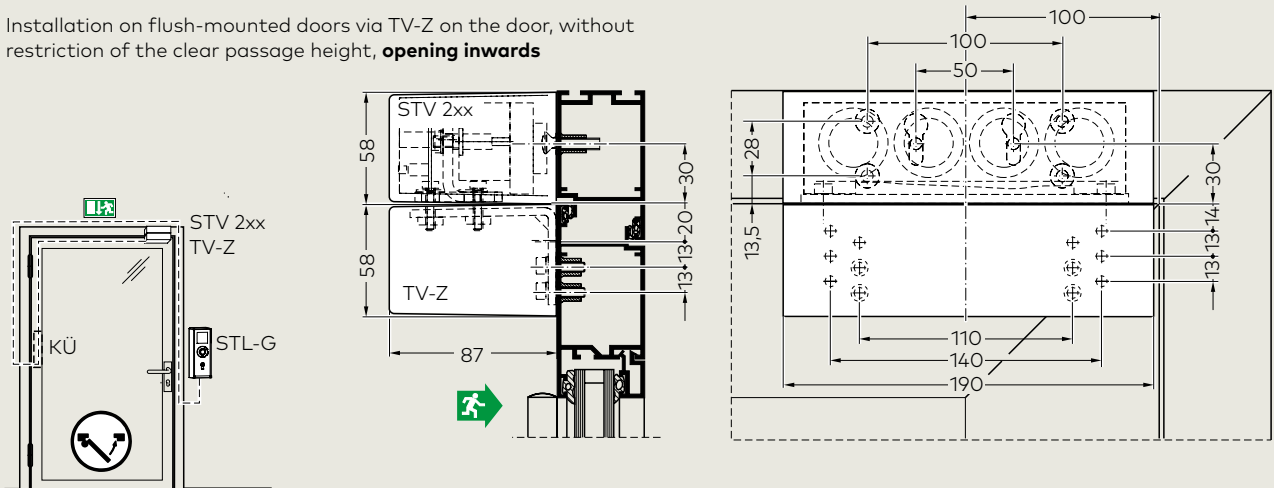

STV 50x – electromechanical door locking device for covered frame installation

Electromechanical door locking device (closed-circuit current principle) for covered frame installation. Connection to the SCU exclusively via 4-wire DCW® bus. The STV 50x door locking system opens without jamming and without delay. The maximum keep-closed force corresponds to EltVTR (German directive for electrical locking systems on escape route doors) and EN 13637 Class 3.

- Integrated contacts for monitoring the active/inactive status
- Concealed frame installation for vandalism protection
- Easy set-up with adjustable latch and reliable operation thanks to DCW® bus technology
- Integrated door status monitoring (door open, door closed)

STV 50x door locking device Supply with flange-mounted strike plate and hardware bag.

Power supply via DCW® bus

power input 80 mA (locked), 20 mA (unlocked) Class of protection IP 32

Temperature range -10 to +55 °C,

Rel. humidity 93% (non-condensing)

Order no

STV 501	With angled strike plate for rebated doors DIN-L	56442501
STV 502	With angled strike plate for rebated doors DIN-R	56442502
STV 505	With bolted flat strike plate for non-rebated doors DIN-L	56442505
STV 506	With bolted flat strike plate for non-rebated doors DIN-R	56442506
STV 507	With bolted flat strike plate and latch guide for non-rebated doors DIN-L	56442507
STV 508	With bolted flat strike plate and latch guide for non-rebated doors DIN-R	56442508

Additional special strike plates can be found in the price list.

STV 501/STV 502

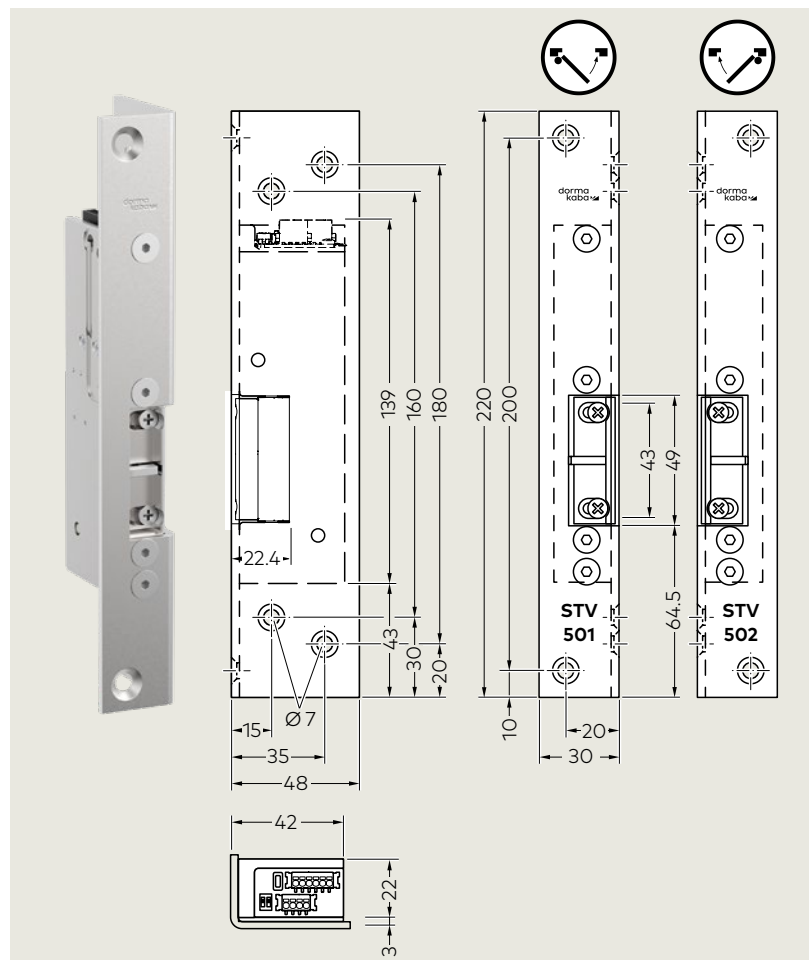

F Certificate of suitability

Installation on fire and smoke doors is only allowed if the usability certificates for these doors and their requirements are observed. Country-specific regulations must be observed.

STV 505/STV 506

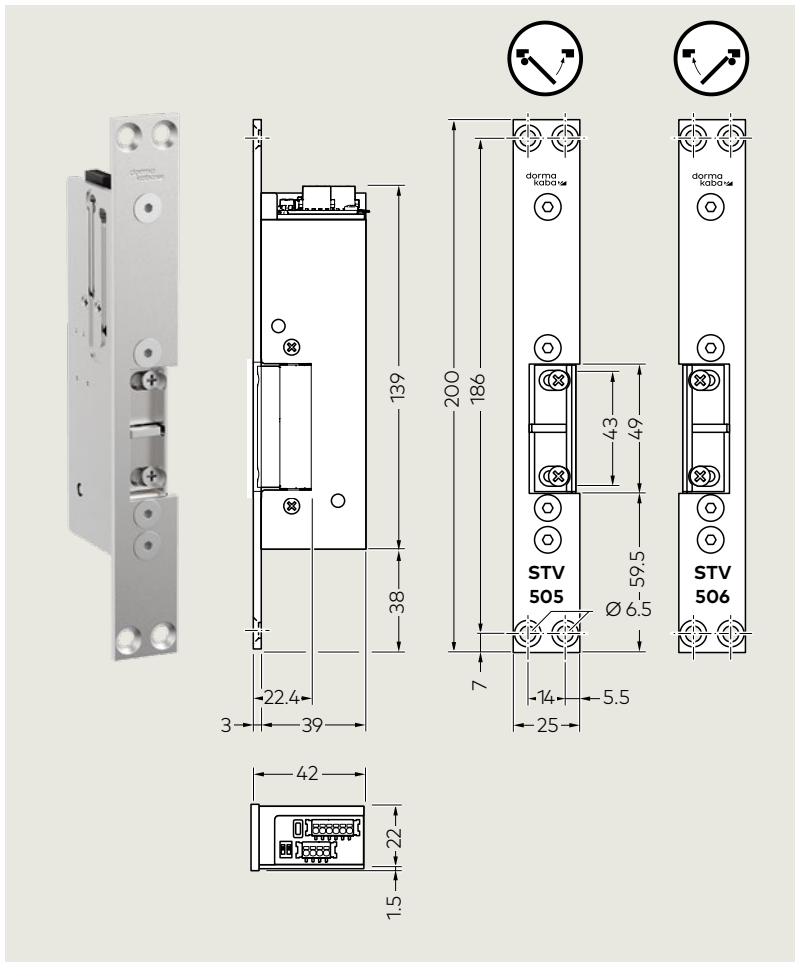

STV 507/STV 508

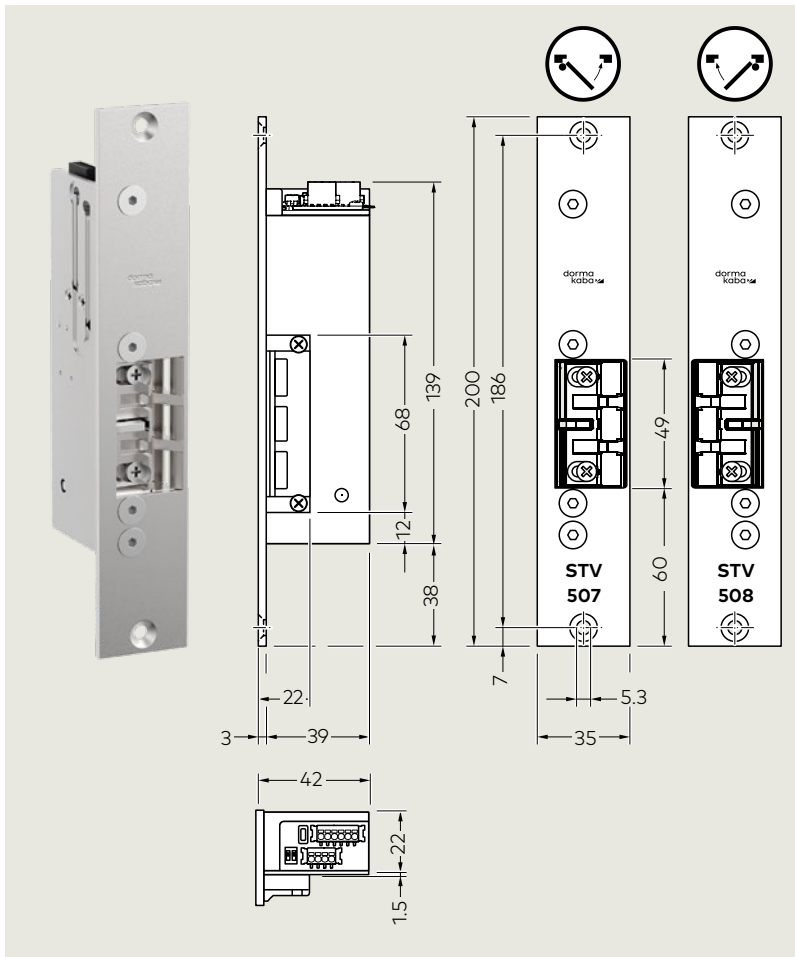

TV-Z 510

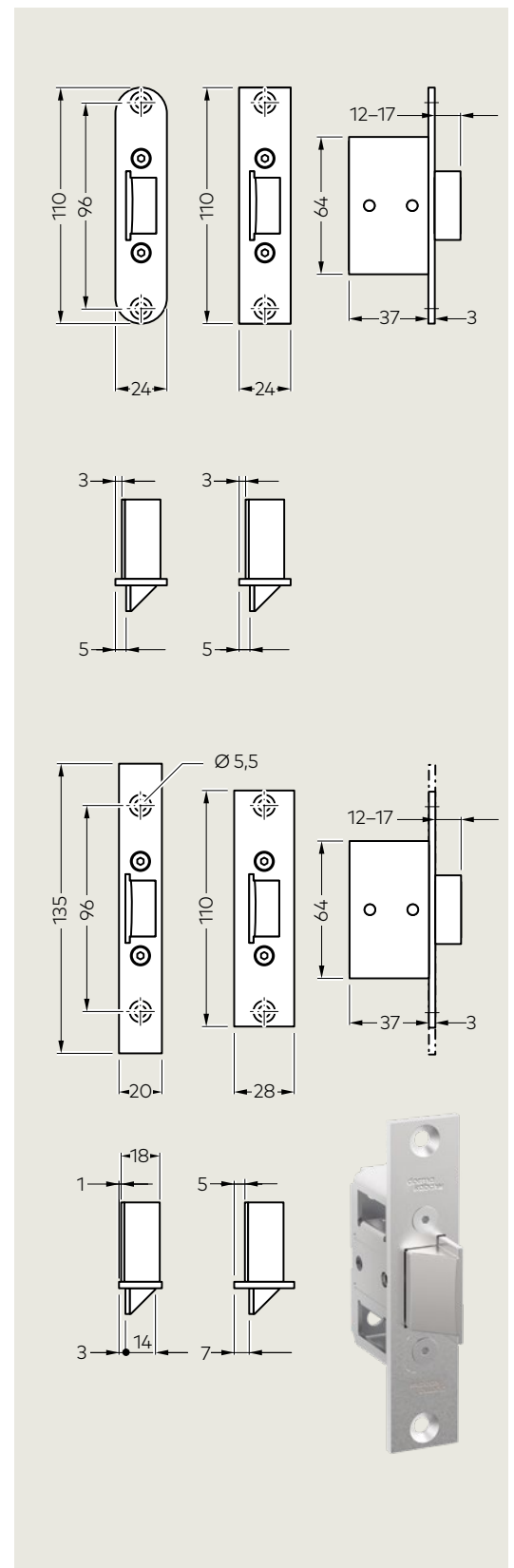

TV-Z 510

Mortise latch lock as counterpart to STV 50x for installation in door leaf.

Order no

Faceplate 24 x 110 x 3	15198124
Faceplate 24 x 110 x 3, rounded edges	15198224
Faceplate 28 x 110 x 3	15198128
Faceplate 20 x 110 x 3	15198120

TV 550 – Analogue electromechanical door lock for concealed frame installation



Electromechanical door lock (closed-circuit current principle) for concealed frame installation. Connection to the SCU exclusively via STV-A adapter. Clamp-free and instantaneous opening. The maximum locking force complies with EItVTR and EN 13637 class 3.

- Integrated monitoring „TV active/inactive“ as well as „Door open/closed“
- All variants with adjustable latch

TV 550	DIN-universal	15155024	435,00
TV 550 Easy Adapt with latch guide „Easy Adapt“	DIN-universal	15155074	435,00
TV 550 Easy Adapt 2 with latch guide „Easy Adapt“ for particularly small distances between frame mirror and latch (9.4 mm to 4 mm)	DIN-universal	15155084	435,00

STV-A adapter for connecting door locking devices without DCW® interface

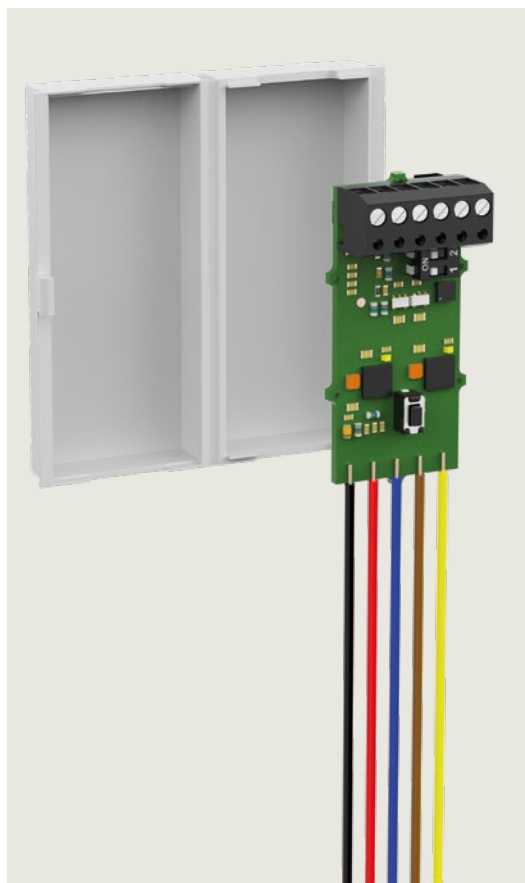

STV-A adapter for analogue dormakaba door locking devices or for integration of foreign products with analogue switch contacts without DCW® bus interface (certifications in accordance with EItVTR or EN 13637 must be observed).

- Easy set-up (configuration LED) and reliable operation thanks to DCW® bus technology
- Smaller size with protective housing for installation in door frame
- 24 V switched voltage for door locking device magnet
- Analogue querying of latch, anchor and door contact

Technical data

Supply voltage	24 V DC ± 15%
Holding force	Dependant on locking device
Power input	20 mA (STV-A), plus power input (max. 800 mA) for the certified electric locking device
Class of protection*	IP 32
Temperature range*	-10 °C to +55 °C
Rel. Humidity*	up to 93% (non-condensing)
Dimensions	31 x 63 x 17 mm

* Cable length between STV-A and analog locking element max. 5m. This data applies exclusively to the STV-A adapter. The certified electrical locking device used may deviate from the data above.

STV-A adapter	Order no. 56442900
----------------------	------------------------------

SVP self-locking emergency escape locks

High building security, more day-to-day comfort and flexibility



SVP 2xxx DCW® and M-SVP 22xx DCW® self-locking motorised emergency escape locks in a SafeRoute system increase protection against break-ins and expand the scope of functions of escape route doors.

- Access from outside without additional key switches. Short-term unlocking is done via the SVP lock cylinder.
- Monitoring and response functions "Door open/closed", "Lock locked/unlocked", "Lever handle operation/emergency unlocking"
- Can be combined with automatic revolving door drive
- Heightened break-in protection (insurance compliant locking) in suitable door systems, up to RC4 with multiple locking emergency-escape lock M-SVP 22xx DCW®
- In combination with SafeRoute components from SLI Basic licence card upwards
- Easy set-up and reliable operation thanks to DCW® bus technology
- Visualisation, control and parametrisation via TMS Soft® (with interface to superordinate building management systems)

SVP 2xxx DCW® and M-SVP 22xx DCW® are available in different design variants for timber and framed doors. Detailed information can be found in the technical brochure for SVP self-locking emergency escape locks.

SafeRoute functions SVP 2xxx DCW® and M-SVP 22xx DCW® depends on the licence card inserted in the SCU (master)

	SLI Basic	SLI Standard	SLI Premium
Access from outside via the profile cylinder	●	●	●
Monitoring and response functions "Door open/closed", "Lock locked/unlocked", "Lever handle operation/emergency unlocking"	●	●	●
Permanent Open with automatic revolving door drive (daily operation)	●	●	●
Visualisation, control and parametrisation via TMS Soft® (with interface to superordinate building management systems)	●	●	●

- Not available

○ Available, not configurable ● Available and configurable

Analogue SVP 4xxx/6xxx are both combinable with SafeRoute and allow for increased comfort functions as well as insurance-complying locking, connectable to the DR or UP/TL variants with the Standard licence as well as an I/O module.

STV-ETS adapter for turnstiles

Access control and SafeRoute



01

Turnstiles such as sensor barriers, swing doors and tripod barriers are used for access regulation and access control. In the event of alarm or danger, the systems must release the escape route. dormakaba offers a suitable solution for every requirement. In terms of a SafeRoute system, the systems meet the requirements of EN 13637 and EltVTR, as far as the applicable standards permit it.

- Automatic releasing of escape routes in the event of alarm and danger
- Central controlling and monitoring of up to four systems with only one SafeRoute Control Unit (SCU)
- Visualisation and controlling via TMS SoftR possible (with interface to superordinate building management systems)
- Easy set-up and reliable operation thanks to DCWR bus technology



02



03

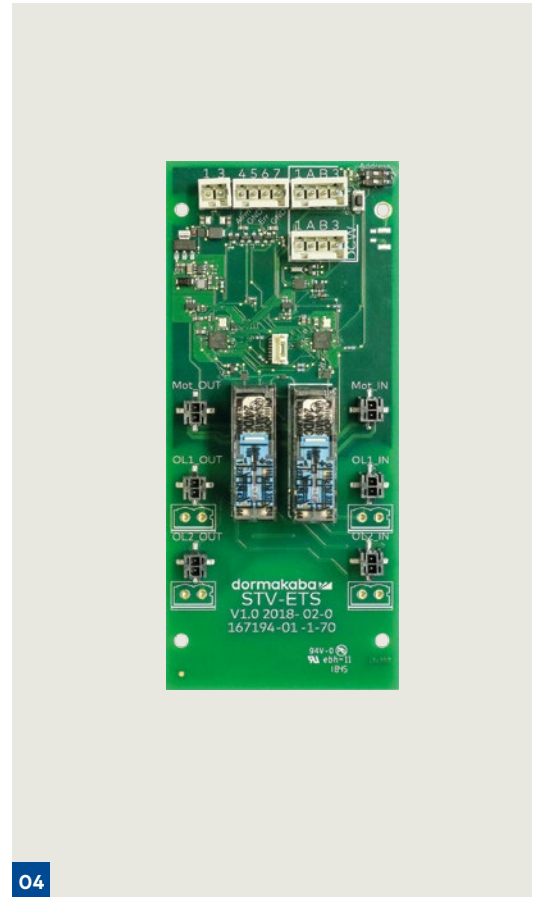

04

Requirements

- The turnstile system is operated with the ETS22cc PCB, e.g. Argus, Charon or Kerberos
- The STV-ETS adapter is required for connecting the ETS22cc PCB to the DCWR bus
- The escape function is controlled using a SafeRoute Control Unit (SCU-UP, SCU-TL or SCU-DR)
- Each system must be equipped with a separate STV-ETS and at least one emergency button for release

- 01 Argus sensor barriers with integrated SafeRoute emergency exit and escape route system
- 02 Kerberos turnstile
- 03 Charon swing doors
- 04 STV-ETS adapter

STV-ETS adapter technical data

Supply voltage	24 V DC ±15%
Power input max.	max. 42 mA
Protection class**	IP 00
Temperature range*	-10 bis +55 °C
Rel. humidity:	up to 93% (non-condensing)

Order no.

STV-ETS Adapter

16719401175

TMS Soft® – door management

Configure, visualise and control central doors



System requirements:

PC with at least Intel Core i5 or AMD Ryzen 5 processor, 8 GB main memory, 1 GB of free hard-drive capacity, graphic card with min. 1280 x 768 pixel resolution, mouse, serial interface/USB port, Windows 8 or 10 operating system.

The universal PC software for comfortable control, management, monitoring and documentation of networked door systems (escape route security, lock systems, revolving door drives, sliding door drives, bi-folding door drives, I/O modules, Central Management Control technology etc.). An unlimited number of door systems can be managed in real time with TMS Soft®.

Also viable for local parametrisation of SafeRoute and TMS standalone systems via serial interface.

Functions

- Management, monitoring and documentation of doors and their functions
- Changes to the default settings (parameters), e.g. unlocking and re-locking times, times until pre-alarm and main alarm
- Changes to the default settings for the analogue inputs and outputs of the SCUs and the I/O modules
- Parametrisation for the SVP/M-SVP lock functions
- Parametrisation for the multi-door control, airlock control and logic function applications
- Setting timer functions and definition of the time period
- Setting brightness and flashing frequency of light ring
- Administration of integrated access controls with the code keypad

Monitoring

- Remote unlocking of doors
- Alarm management (activation/deactivation of alarms)
- Tampering monitoring
- Open door monitoring
- Historical memory of door events

Networking

- Via LON or LAN
- Connection to building management via an optional OPC server
- ESPA interface for telecommunications systems

Detailed information on TMS Soft® can be found in the dormakaba TMS manual

www.dormakaba.com/saferoute/downloads



		Order no.
TMS Soft® V5.x Basic	Control unit, parametrisation and visualisation software for SafeRoute and TMS individual systems via serial interface. USB to serial adapter is required where necessary. See below. Software available as free download from dormakaba.com.	56480001
TMS Soft® V5.x	Control unit, parametrisation and visualisation software for dormakaba door systems via serial interface. USB to serial adapter is required where necessary. See below. Delivery of software on USB stick and serial connection cable. TMS Soft® full version with LON/LAN network connection, parametrisation of dormakaba door drives and data provision for building management systems via OPC or telecommunication systems via ESPA server.	56480002
TMS OPC Server	To couple the TMS Soft® with OPC-supporting building or security management systems. The TMS OPC server supports the following OPC (OLE for process control): <ul style="list-style-type: none"> • Data Access V1.0A • Data Access V2.05 • Data Access V3.0 • Alarms and Events Specification 1.10. • Conditional Alarms from 1/2009 The OPC server: <ul style="list-style-type: none"> • is implemented as OutProc-COM service • supports the Windows 2000, XP, Vista, 7, 8 and 10 operating systems Doors in TMS Soft® are provided as a data point with all status bits. Individual bits can be defined as a data point through configuration via an XML file. Alarm and Event (AE) is possible for complete data points or individual bits of a data point. AE supports the type "Simple Event" and supplies data point values. Furthermore, "AE Conditional" is supported with "acknowledgement" (acknowledgement-dependent alarms and events).	56339150
ESPA 4.4.4.	Software interface between TMS Soft® from V4.x onwards and telecommunications systems.	56339130
USB/RS232 adapter	Converter module RS232 with USB connection. Enables the connection between PCs without serial port and the TMS PC adapter.	1900070402708
USB/LON network adapter	Gateway for networking of dormakaba door management systems with TMS LON modules and for connection via USB to PC systems with dormakaba TMS Soft®.	56333403

Central Management Control

Central visualization of doors and control without PC

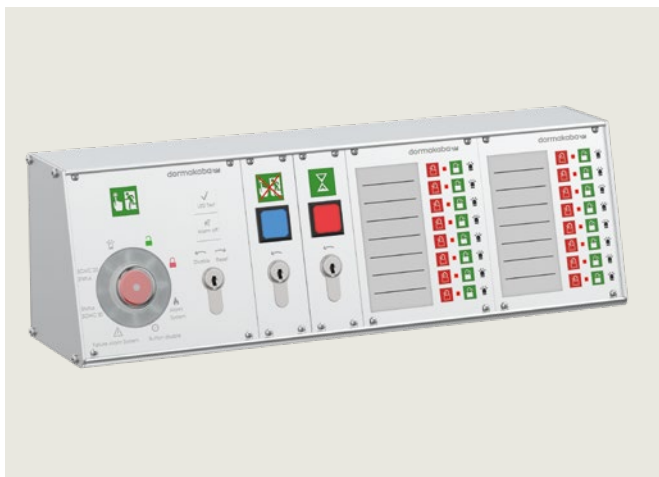

The SafeRoute Central Management Controls (SCMC) enable individual doors, door groups and spatial sections to be monitored and controlled in real time. Depending on the requirements, a panel system can be assembled individually. Additional functions can be enabled by using tableau extensions and connecting external control devices.

- Central control and monitoring of SafeRoute escape doors
- Central activation of individual doors and sections, e.g. from a constantly manned control room
- Selective opening of individual doors
- Definition of door groups or door sections
- Locking or delay of release upon pressing the emergency button on site (protection against misuse of escape routes)
- Connection via the LON network or LAN network

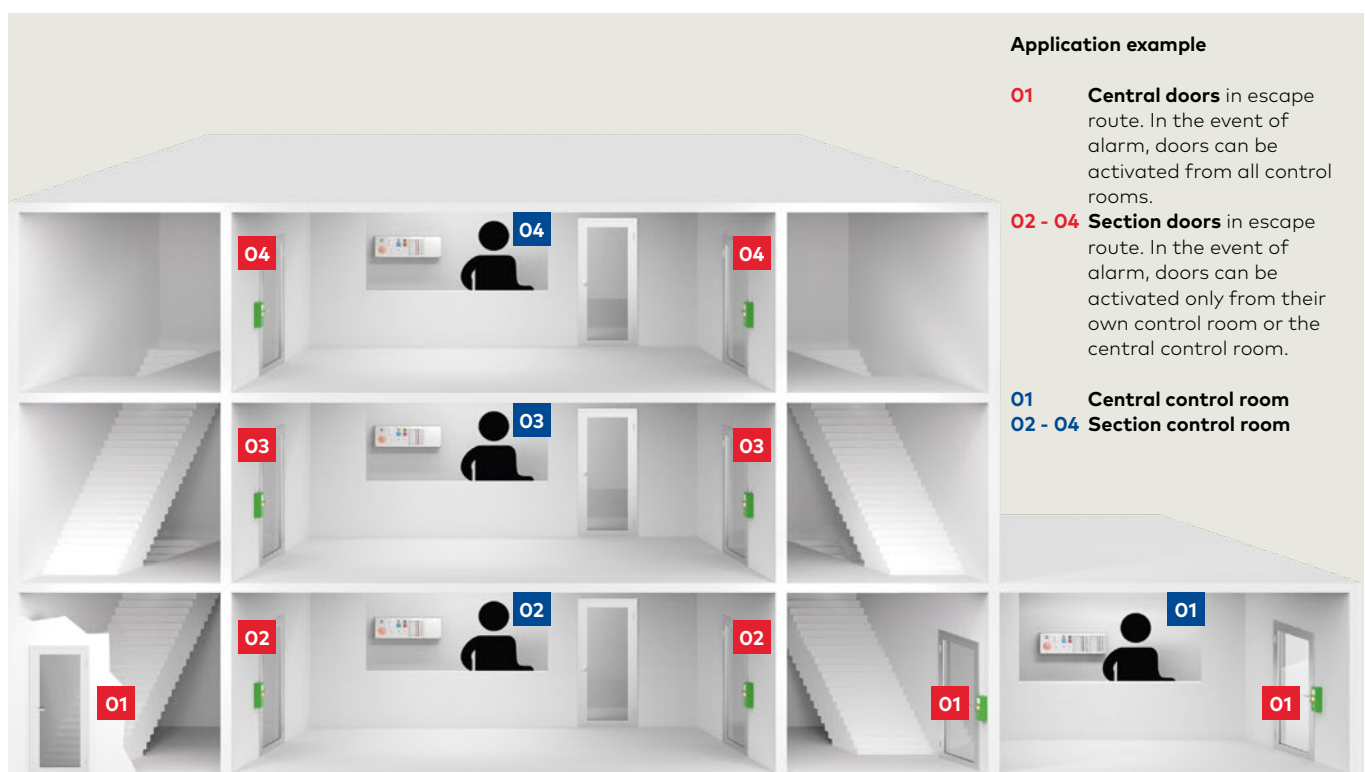

Application example

01 **Central doors** in escape route. In the event of alarm, doors can be activated from all control rooms.

02 - 04 **Section doors** in escape route. In the event of alarm, doors can be activated only from their own control room or the central control room.

01 **Central control room**

02 - 04 **Section control room**

SCMC-H panel housing

The SCMC-H panel housing is for the table or wall mounting in interior spaces. The housing acts as a support for the 19" panel components and can be closed with optional blind plates.

- Table or wall mounting
- Support width: 84 TE (horizontal pitches)
- Class of protection IP 30

	Bestell-Nr.
SCMC-H panel housing Dimensions: 429 x 133 x 102 mm	56460012
SCMC01 blind plate 8 TE	56460001
SCMC02 blind plate 21 TE	56460002

SCMC20: Basic unit with emergency button

The SCMC20 control unit is a 19" panel component for controlling and monitoring a single SafeRoute escape route door or a group of SafeRoute escape route doors. With the emergency button and/or a connected alarm system, the doors are released centrally. The light ring indicates the current status of the doors or the door group. The SCMC20 is connected to the SafeRoute escape route doors (SCU master) via a LON network.

Functions

- Central activation of assigned SafeRoute escape route doors using the integrated emergency button
- Status display of escape route doors assigned
- Alarm display
- Can be extended with the panel components SCMC30, SCMC40 and SCMC80

Technical requirement (additionally required)

- SLON-UP network adapter for connecting the SCMC20 to the LON network
- External power supply, e.g. plug-in power supply SCMC NT (24 V/420 mA)
- Lock cylinder 30/10 (design as profile cylinder)
- SLI Premium license card in the assigned SafeRoute panels (SCU Master)
- Parametrisation and installation is done with TMS Soft® Professional 5.x and LON Binding

Technical data

Supply voltage:	24 V DC ± 15% or better	
Power input:	Closed-circuit current	75 mA
	LED test	135 mA
Class of protection:	IP 30 (depending on the housing used)	
Temperature range:	-10 to +55 °C	
Rel. humidity:	up to 93% (non-condensing)	
Dimensions:	132 x 128 x 60 mm, 19" component (26TE)	

	Order no.
SCMC20	56460020
SCMC NT (no image)	56366005
SLON-UP network adapter (no image)	56450010

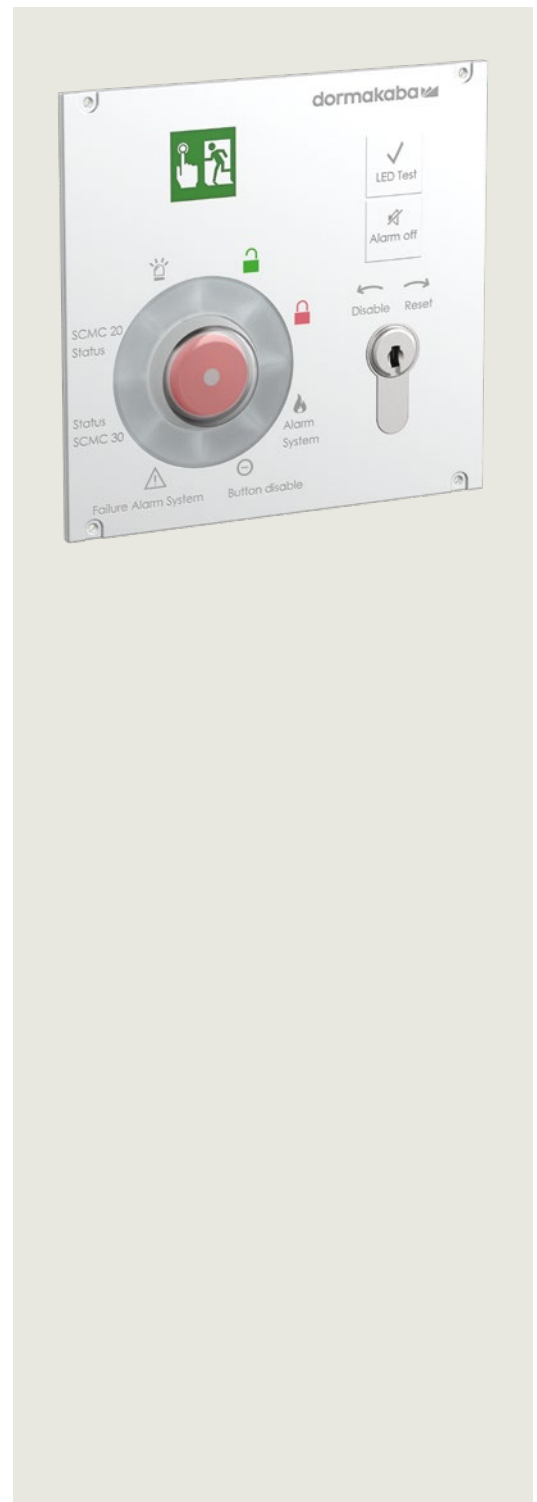



SCMC30: Panel extension for activation of blocked release

The SCMC30 panel unit is an extension to SCMC20 Control Unit. With the panel extension SCMC30, you can activate the „locked activation“ mode according to EN 13637 to disable the local emergency button of a SafeRoute escape route door. Activation is only possible from a central location when this function is enabled.

- Key switch for activating the function
- Illuminated button as status display „Lock active/inactive“
- Connection is done via the ribbon cable included in supply to the SCMC20 Control Unit

Safety instruction

Use of the „Locked activation“ functions according to EN 13637 is only permissible when there is a central activation and a constantly manned spot. The country-specific building law as well as relevant laws, regulations, guidelines, standards, etc. must be observed.

Technical data

Power supply:	Via the connection to SCMC20
Class of protection:	IP 30
Temperature range:	-10 to +55 °C
Rel. humidity:	up to 93% (non-condensing)
Dimensions:	128 x 41 x 52 mm 19" component (8 TE)

Order no.

SCMC30

56460030

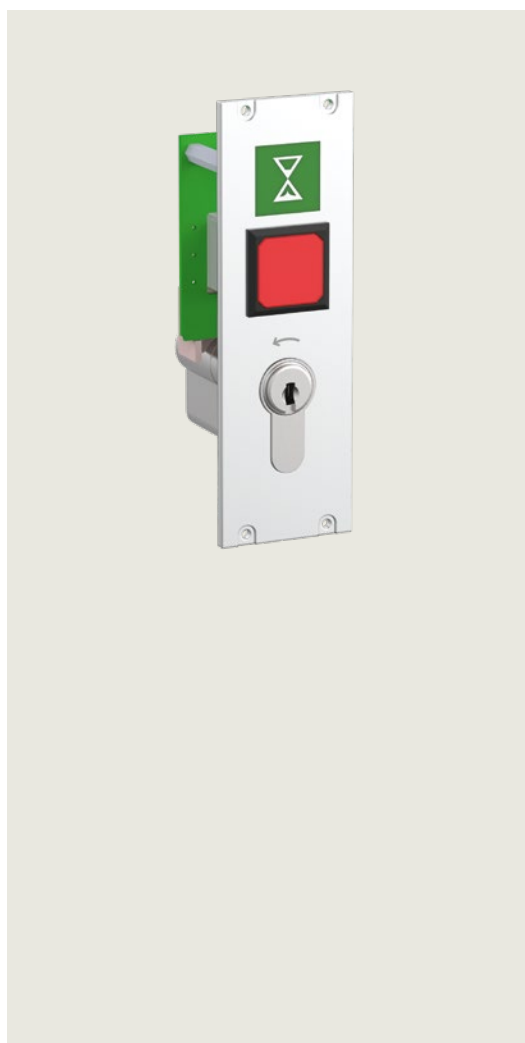

SCMC40: Panel extension for activation of time delay

The SCMC40 panel unit is an extension of the SCMC20 Control Unit. The activation of escape route doors upon pressing the emergency button on the escape route door can be delayed once by a maximum of 15 seconds (T1 delay according to EN 13637). As long as T1 is active, an additional T2 delay of up to 180 seconds can be activated once at the panel extension SCMC40.

- Key switch for activation of the function
- Illuminated button as status display „Delay active/inactive“
- Connection is done via the ribbon cable included in supply to the SCMC20 Control Unit

Safety instruction

Use of the „Time delay T2“ functions according to EN 13637 is only permissible when there is a central activation and a constantly manned spot.

Technical data

Power supply:	Via the connection to SCMC20
Class of protection:	IP 30
Temperature range:	-10 to +55 °C
Rel. humidity:	up to 93% (non-condensing)
Dimensions:	128 x 41 x 52 mm 19" component (8 TE)

Order no.

SCMC40

56460040

SCMC80: Display and operation panel for controlling individual doors

The SCMC80 is an 19" panel component for visualisation and control of up to 8 individual doors. In conjunction with a central activation unit SCMC20, up to eight SCMC80 can be integrated via a four-core cable (DCW®-Bus) for a panel unit for max. 64 doors.

Visualisations and controls can be implemented in any number with a SLON or SLAN adapter for each panel insert.

Functions

- Central locking and unlocking of individual escape route doors
- Door status display (locked, permanently unlocked, unlocked for a short time, unlocked for a long time)
- Alarm display if an alarm has been triggered on site
- Display if the escape route door is locked via an SCMC20
- Label field for identification sheet

Technical requirement

- DCW® operation: The SCMC80 is an extension of the SCMC20 Control Unit. The connection to the SCMC20 takes place via the DCW® bus.
- LON- or LAN operation: The SCMC80 is connected to the SafeRoute escape route doors (SCU master) via a LON- or LAN network. Each SCMC80 must be extended with one SLON- or SLAN network adapter. An external 24 V DC power supply is required.
- Parametrisation and installation is done with TMS Soft®

The SCMC80 panel can be used as parallel display for TMS Soft 5.x visualisation and control via LON and LAN network. Alternatively, the panel insert SCMC80 can also be used via LON binding for visualisation and control of up to 8 doors for each panel insert without using the TMS Soft 5.x.

Technical data

Supply voltage:	24 V DC ± 15%
Power input:	
	10 mA
LON operation with SLON-PL	25 mA
LAN operation with LAN module	50 mA
Class of protection*:	IP 32
Temperature range*:	-10 to +55 °C
Rel. humidity*:	up to 93% (non-condensing)
Dimensions:	31 x 63 x 17 mm 19" component (21 TE)

Order no.

SCMC80 56460080

SLAN-PL network adapter

SLAN-PL as LAN adapter for TE25/80 and for TMS/SVP controls. Enables the connection to the LAN TCP/IP network.

SLAN-PL 56353001

SLON-PL network adapter

SLON-PL as LON adapter for TE25/80 and for TMS/SVP controls. Enables the connection to the LON network.

SLON-PL 56450010

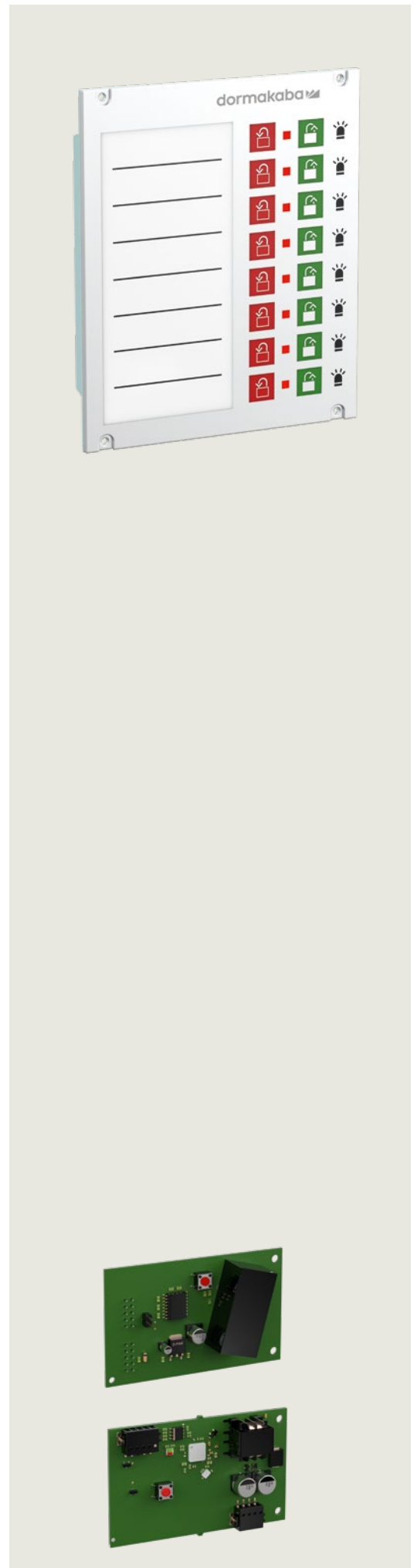

Safety instructions pursuant to EltVTR

SafeRoute escape route security systems are developed and manufactured in accordance with recognised state-of-the-art technology and recognised safety regulations. They are pursuant to the EltVTR (German directive for electrical locking systems on escape route doors) – December 1997 version – published in communication 5/98 of the DIBt (German Institute for Civil Engineering), Berlin. Test certificates from the MPA NRW and the VdS Cologne are available.



The installer and facility operator must observe the following instructions as escape route security systems must not be an obstacle in the unhindered escape of persons in case of danger.

Use

Escape route security systems are electrical locking systems in escape route doors that counteract improper use of the escape route.

The technical data and ambient conditions must be taken into account while using the SafeRoute escape route security systems (see also the technical product documentation of dormakaba).

(Preliminary) construction inquiry/approval procedure

Escape route security systems are construction products regulated in Germany in accordance with Model administrative regulation Technical building regulations (MVV TB) Point C 2.6.11 or Building Rules List A, part 1, point 6.19. On the grounds of some special building regulations, it may be required to apply for an exemption in terms of §67 Model Building Regulation. For this, claims in accordance with DIBt 5/98 must be included as collateral clauses in the building permit of the object. As the state of the art recognised across Europe, the use of EN 13637 for electrically controlled escape route systems is recommended so long as this does not contradict the building law applicable at the time of construction at the place of use. Country-specific regulations must be observed as a matter of principle.

Planning and installation

A SafeRoute security system consists of at least one door terminal, one SCU control unit, one emergency button (or a relevant combination of these), one SLI Mini licence card and one electric door locking device (STV 1xx, STV 2xx or STV 5xx). The following can be attached depending on the licence card selected: additional emergency button, additional key switch or access control, emergency switch locks with automatic locking action or motor locks, flashing lights or external alarm siren, automatic swing door operator, power supply unit with emergency power supply as well as fire and/or hazard alert system or smoke detector.



The door locking device on the escape route doors may be operated only with the products approved by dormakaba for this purpose.

The door terminal (local activation) should be fixed in the immediate vicinity of the handle in such a way that the emergency button is at a height of 850 mm to max. 1200 mm above the floor.

The emergency button must be indicated with the "emergency exit" label. The label must be affixed in such a way that the arrow points to the emergency button.

In buildings with automatic extinguishing devices, fire alarm or other hazard alarm systems, it is logical that the escape route doors secured with SafeRoute are automatically unlocked when these systems are triggered.

If there is a central unit permanently manned during operation with direct access to the escape route doors, release may also be carried out using this central unit.

The features of the fire and smoke doors must not be impaired by the installation of a door locking device (fire resistance duration or smoke control and self-locking function).

Changes to the fire protection terminals that are required for installation of door locking device and that are beyond the scope of the change permissible in the DIBt bulletin of 1/1996 require the general building inspectorate approval or consent from the responsible building authority in individual cases.



Service instructions

- Only use dormakaba spare parts or accessories approved by dormakaba.
- Any work on electrical devices that are not operated with safety extra-low voltage may only be carried out by a qualified electrician.
- The installation, commissioning and maintenance may only be done by a qualified person authorised by dormakaba.
- The key for products that are not operated with safety extra-low voltage may only be handed over to a qualified electrician.

Provisions

The below standards and guidelines (current version) must be observed:

- DIBt communication 5/98 German directive for electrical locking systems on escape route doors (EltVTR)
- DIBt communication 1/96 Changes to fire protection terminals
- DIN VDE 0100, 0800, 0815 Provisions on installing the electrical devices
- DIN 0833 – Part 1–3 Requirements for hazard alarm systems (GMA) for fire, burglary and attack
- Building rules list A part 1
- Special building regulations

Country-specific regulations, standards and guidelines must be observed.

Safety instructions pursuant to EN 13637

SafeRoute escape route security systems are developed and manufactured in accordance with recognised state-of-the-art technology and recognised safety regulations. They comply with the specifications of EN 13637:2015-12 "Locks and building hardware – electrically controlled exit systems for use on escape route doors – Requirements and test methods". Test certificates of the MPA NRW are available.



The installer and facility operator must observe the following instructions as escape route security systems must not be an obstacle in the unhindered escape of persons in case of danger.

Use

SafeRoute escape route security systems enable the electric controlling of exit systems in accordance with EN 13637 with electric control units, initiation elements and locking devices. It should counteract the improper use of an escape route. While using the SafeRoute escape route security systems, the technical data and ambient conditions should be taken into account (also see the technical product documentation of dormakaba on this).

(Preliminary) construction inquiry/approval procedure

SafeRoute escape route security systems correspond to the recognised state-of-the-art and the specifications of EN 13637. On grounds of some special building regulations and possibly conflicting national building regulations, it may be necessary that the use of EN 13637 or of individual functions in accordance with EN 13637 requires an approval from the responsible local planning and building authorities. Country-specific provisions are to be checked and observed as well as, if required, are to be included in the building permit of the object as collateral clauses.

Planning and installation

A SafeRoute system is comprised of at least a door terminal, control unit, door locking device and SLI licence card components. The following can be attached depending on the licence card selected: additional emergency button, additional key switch or access control, emergency switch locks with automatic locking action or motor locks, flashing lights or external alarm siren, touchscreen displays, networking modules, I/O modules, automatic swing door operator, power supply unit with emergency power supply as well as fire and/or hazard alert system or smoke detector.



The door locking device on the escape route doors may be operated only with the products approved by dormakaba for this purpose.

In buildings with automatic extinguishing devices, fire alarm or other hazard alarm systems, it is logical that the escape route doors secured with SafeRoute are automatically unlocked when these systems are triggered.

Position of door terminals

The door terminal (local activation) should be fixed in the immediate vicinity of the escape route door in such a way that the emergency button is at a height of 800 mm to max. 1200 mm above the floor and is max. 600 mm away from the escape route door.

Indication of emergency button

The emergency button has to be indicated depending on the version of the system (with or without time delay) with the pictogram for electrically controlled exit systems in accordance with EN 13637 or EN ISO 7010:2012. The size of the pictograph is at least 8000 mm², or at least 2500 mm² for active lighting of the pictograph. The

pictograph must be affixed in the immediate vicinity of the emergency button.

Central escape route control system/CMC

If there is a constantly manned central spot during operation with view of the escape route door (either direct or through video monitoring), the controlling can also be done from this central location (central management control). An activation of delay Level 2 and/or locking the release are permissible in accordance with EN 13637 only in connection with a CMC unit. Country-specific regulations must be observed.

Fire and smoke protection requirements

The features of the fire and smoke doors must not be impaired by the installation of a door locking device (fire resistance duration or smoke control and function of self-locking). Changes to the fire protection terminals that are required for installation of the door locking device and that are beyond the scope of the changes permissible in the respective country require a building inspectorate approval, if applicable, or consent in individual cases. An agreement with the permit holder of the fire protection terminal and/or the responsible local planning and building authorities may be required. Country-specific regulations must be observed.



Maintenance guide

Only use dormakaba spare parts or accessories approved by dormakaba. Any work on electrical devices that are not operated with safety extra-low voltage may only be carried out by a qualified electrician. Installation, commissioning and maintenance may only be done by a qualified person authorised by dormakaba. The key for products that are not operated with safety extra-low voltage may only be handed over to a qualified electrician. Country-specific provisions for the routine check of exit systems must be observed.

Provisions

In addition to the regulations of EN 13637, the country-specific building law as well as standards, provisions and guidelines, particularly on use of escape route security systems, on changes to fire protection terminals, on installing electric devices, regulations for hazard alarm systems, special building regulations and other relevant regulations must be observed in their respective latest version.



**Door
Hardware**



**Electronic
Access & Data**



**Mechanical
Key Systems**



Lodging Systems



**Entrance
Systems**



**Interior Glass
Systems**



Safe Locks



Service

dormakaba
International Holding AG
Hofwisenstrasse 24
CH-8153 Rümlang
T +41 44 818 90 11
info@dormakaba.com
www.dormakaba.com